



ALLPLASTA

Quality Hand Crafted Plaster Products

Product Catalogue



www.allplasta.com.au

Bring Quality Home

Allplasta is the Australian market leader with premium quality, design and exceptional customer service. For over 20 years, we have produced only the highest quality plaster cornices, ceiling roses and other plaster products.

All of our products are handcrafted in our workshop from sharp, detailed moulds. Our traditional methods combined with modern manufacturing efficiency and an attention to detail that is rarely found elsewhere, result in the finest quality plaster products.

We specialise in creating detailed custom products for architects, interior designers and home decorators. These services include heritage work, restorations and reproductions.

Anything is possible!

Pictured
Custom curved wall panelling made to suit curved raking wall.
Curved AS40 Strip, A121 Cornice, APC5 Columns

Contents

| | |
|--|------------|
| We Specialise In | 1 |
| Instock Range | 8 |
| FAQ | 12 |
| Architectural Periods | 13 |
| Cornices | 15 |
| Ceiling Centres | 40 |
| Medallions & Embellishments | 56 |
| Ceiling Domes | 57 |
| Ceiling Panels | 61 |
| Strips | 75 |
| Strip Corners | 80 |
| Bosses | 82 |
| Cofferred Ceiling Panels | 83 |
| Arches | 85 |
| Corbels | 91 |
| Wall Plaques | 96 |
| Arch Plinths | 97 |
| Arch Keystones | 98 |
| External Staffs | 99 |
| Firesurrounds | 100 |
| Pilasters | 107 |
| Pilaster Capitals | 111 |
| Pediments | 112 |
| Columns | 115 |
| Wall Panels | 117 |
| Wall Niches | 120 |
| Acoustic Pods | 121 |
| Light Sconces | 123 |
| Cornice Mitre Blocks | 123 |
| Plaster Accessories | 124 |
| Vents | 125 |
| Fixing Instructions | 127 |

We Specialise in...

Reproductions

We are able to reproduce any damaged or discontinued plaster products. Renovating or extending? We can replicate almost any profile, restoring them to their original design and perfect condition. Contact us for more details.

A



BEFORE



AFTER

A129 Cornice

B



BEFORE



AFTER

A136 Cornice

C



BEFORE



AFTER

AP31 Ceiling Panel

Domes

Add depth and style to any ceiling or room with our range of standard domes or choose to have a custom dome made especially to suit your room dimensions or architectural style.



AR32 CEILING CENTRE



AD8 CEILING DOME



AD8 CEILING DOME
A121 CURVED CORNICE AROUND DOME POA



CUSTOM DOME
AS39 CURVED STRIP POA

Plaster Columns



APC5 Columns used above

A stunning addition to any entrance or opening. Choose from plain or fluted, short or tall, all custom made to your required height with a choice of capitals. Please ask for more information.

Columns can be painted with a marble finish onsite by expert painters. Please ask for more information.



NEED HELP?

We have experienced design consultants ready to help you with any questions or problems you may have.

Pediments and Pilasters



AFP2 Pilasters & APD3 Pediments used above used above

The use of pediments and pilasters within a doorway create a striking elegant effect.



pilaster AFP2 butted up to a pediment APD 3



A131 cornice mitred around the top of pilaster AFP3

Archways

Curved Cornices



ASE2 Arch with AAP3 plinths and AC24 corbels



A21 Custom curved plaster cornices

A large range of archways are available to suit varying wall widths and openings. Be inspired and enhance the overall effect of your archway in many ways such as adding single or double corbels butted up to a plinth. Or add a wrap-around strip for a simpler, cleaner look. Our beautiful, stylish archways can be custom made to your opening size and design.

Sometimes cornices have to be custom made to suit curved walls or ceilings. Any profile from our extensive range can be selected. All we need is a template or radius giving the shape of the curved wall or bulkhead.



AAP3 Plinth and AC24 Corbel



AS32 Wrap around strip



A22 custom curved cornice

Architecturally Designed Products



The staircase above required custom curved wall panelling to complete the overall look



The arch above was created from a magazine photo to suit a home from the early 1900's

Bring your own ideas or architectural designs to life. From a simple drawing to a detailed plan, anything is possible. Detailed plaster products can be produced for architects, builders, interior designers and home decorators.



Using AWP9 Wall panel you can make a feature wall like the above picture

Architecturally Designed Products

We can custom make almost anything to suit a drawing or architectural plan. Working with you from concept to finished product we can also help you with recommended installation methods.

Different materials can be used such as plaster, fibreglass or light weight resin. Please contact us for more details.

This product designed for Stockland mall, Wetherill Park, where they needed custom acoustic pods for the ceiling in the food court. For this job we manufactured 104 acoustic pods that were 2125 mm x 2125 mm square with a depth of 200 mm. Each pod has 361 x 25 mm perforated holes to achieve the desired acoustic rating.

Firesurrounds

This elegant fireplace is sure to be a feature in any home. Achieving detail second to none, our range of fireplace surrounds are a must to see. We cater for all tastes and styles.

Plasterglass is fire resistant, made from non-combustible gypsum and fibreglass, so it will not burn, spread flame, evolve heat or smoke.



AFS2 Firesurround

One Stop Plaster Shop



We stock, for your convenience, a large range of plasterboard products and tools:

- Plasterboard
- Setting compounds
- 90mm and 55mm paper cornice
- Adjustable mitre boxes
- Basic plastering tools



PAYMENT METHODS

We accept Cash, EFTPOS, Mastercard, Visa, and Direct Deposit.

Instock Range

We have a range of our most popular styles of cornice, ceiling centres and strips in stock and ready to go for delivery or pick up saving you time and money. To view our full instock range visit our website www.allplasta.com.au to see pricing and available lengths. Other styles are available. Don't forget to always check our Instock Range as it is always growing!

SR P16 *Col*

□ 145 mm

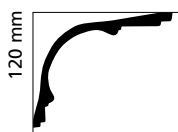

SR A85 *Col*

□ 130 mm

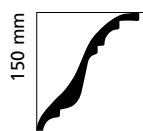

SR A21 *Vic*

□ 130 mm

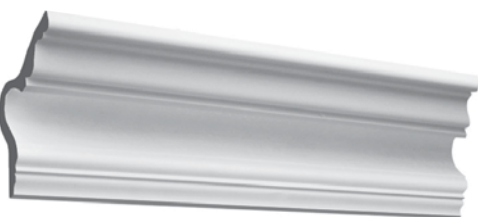

SR A62 *Col*

□ 115 mm

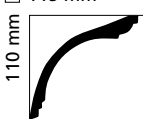

SR A96 *Mod*

□ 160 mm

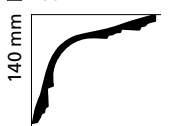

SR P13 *Fed*

□ 150 mm



SR AR38 *Col*

⊖ 650 mm DIAMETER
⊖ 135 mm CENTRE DIAMETER



SR AR40 *Fed*

⊖ 650 mm DIAMETER
⊖ 135 mm CENTRE DIAMETER



SR AR100 *Mod*

⊖ 600 mm DIAMETER
⊖ 130 mm CENTRE DIAMETER



SR AR162 *Fed*

⊖ 530 mm DIAMETER
⊖ 20 mm CENTRE DIAMETER



SR AR168 *Vic*

⊖ 200 mm DIAMETER
⊖ 20 mm CENTRE DIAMETER



INSTOCK RANGE

Premium quality plaster products from sharp detailed moulds. Direct to you at competitive prices, popular styles instock ready to go.



Pictured:
Coffered ceilings using SR A149 cornice from our stock range. you can create a stunning look with a combination of bulkheads and cornice. Please ask for more details.



Pictured
Custom corbels made for rangehood. AD8 ceiling dome with
custom border strip made to suit design given.



Exterior Mouldings

For exterior use, we are able to create a selection of our products or custom mouldings from resin or fibreglass, such as corbels, pediments and flat backed archways.

Pictured
Custom vaulted ceiling made in fibreglass
AP08 & AP09 Pediments made in fibreglass
AC38 Corbels Made in fibreglass

Frequently Asked Questions

DO YOU KEEP ALL YOUR PRODUCTS INSTOCK?

We do keep popular products in stock so please check out our Instock Range on our website www.allplasta.com.au, but please note that our stock levels change every day. Our instock range includes a selection of Cornice, Ceiling Centres and strips. Please contact us to enquire.

HOW LONG DOES IT TAKE TO MAKE OUR ORDER IF IT IS NOT IN STOCK?

Most orders can be made within 10 - 15 days if not earlier, depending on the quantities.

CAN YOU REMAKE PLASTER PRODUCTS THAT ARE NOT ON YOUR WEBSITE?

We are able to reproduce most plaster products if you supply us with a sample or template. We specialise in cornice, ceiling panel, strip and archway reproductions. Please ask for more details.

IS THERE A MINIMUM ORDER FOR CORNICES?

There is no minimum order, however there is a surcharge for orders under 4 lengths of each cornice type.

WHERE DO YOU DELIVER TO?

We deliver throughout Sydney metro as well as Blue Mountains, Central Coast, Bowral, Bathurst, Wollongong & Canberra (POA).

WHAT ARE MY OPTIONS FOR DELIVERY OUTSIDE OF SYDNEY?

This depends on the size of your order. For smaller products (under 21kg total weight) we can use Australia Post and we can custom make timber boxes (POA) to pack the goods to ensure their safe arrival. For heavier or large products, we can make a long pallet (POA), ready for transport around Australia by your choice of freight company. We can also recommend freight companies to help with delivery. Please ask for details.

PLEASE NOTE:

- When choosing a cornice from our range consider the ceiling height & the size of the room to be in proportion with the space. When selecting a cornice we have a recommended ceiling height range on our website to help with your choice.
- If you are trying to match an existing cornice or strip you can print a 1:1 end profile from our website www.allplasta.com.au to confirm a match to any cornice or strips we make.
- No plaster products are returnable or refundable.
- Cornices are manufactured in 4800mm, 4200mm and 3600mm lengths unless otherwise stated on a page.
- Please check with our office when making your selection as some plaster products take up to 15 working days to manufacture. Please leave your name and telephone number so we can contact you once your order is complete.
- All measurements are approximate and subject to change without notice.
- AllPlasta reserves the right to vary designs without any notice. © Copyright AllPlasta Pty Ltd.

Architectural Periods

1750

1800

1850

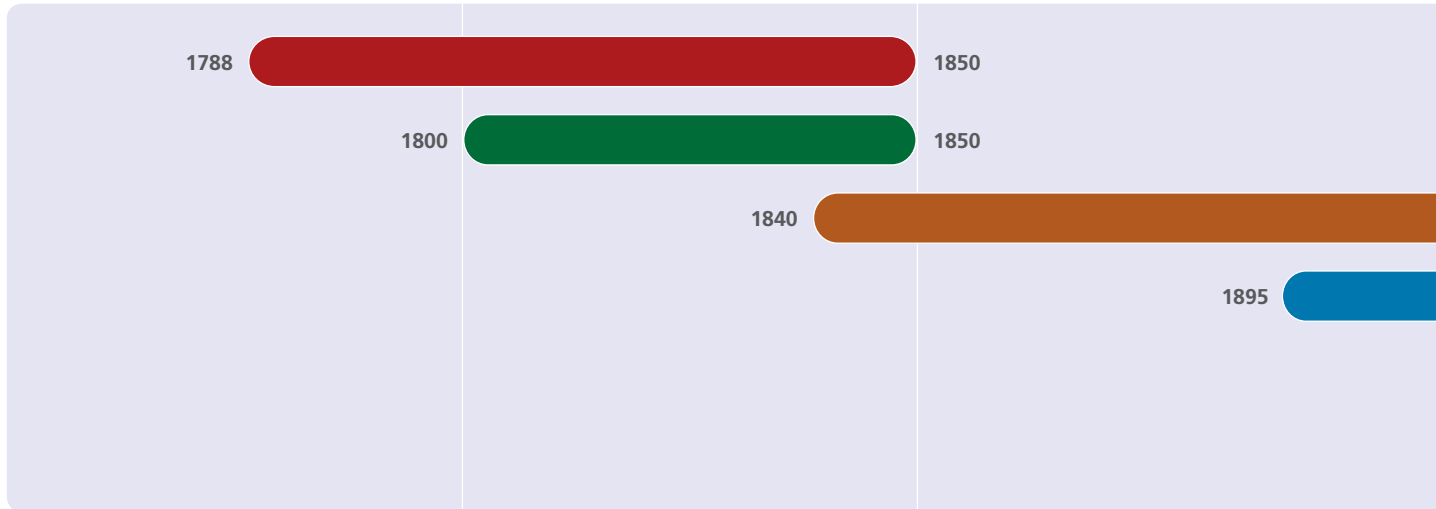

Colonial

Col



AR92

Simple fine lines and soft curves with wave patterns and plain sections. This design period includes very few decorative elements.



P16

Georgian

Geo



AR57

Characteristically symmetrical and formal comprising patterns such as dental blocks, egg and dart, acanthus leaf and corbelling. Bold and striking, invoking a feeling of grandeur.



A146

Victorian

Vic



AR19V

Typically elaborate and richly detailed. Featured in terrace houses. Patterns make use of deep covered sections known as the Paddington style, as well as leaf patterns with minimal flowers. Displays balance, proportion and elegance.



A165A/B

Timeline

1900

1950

2000

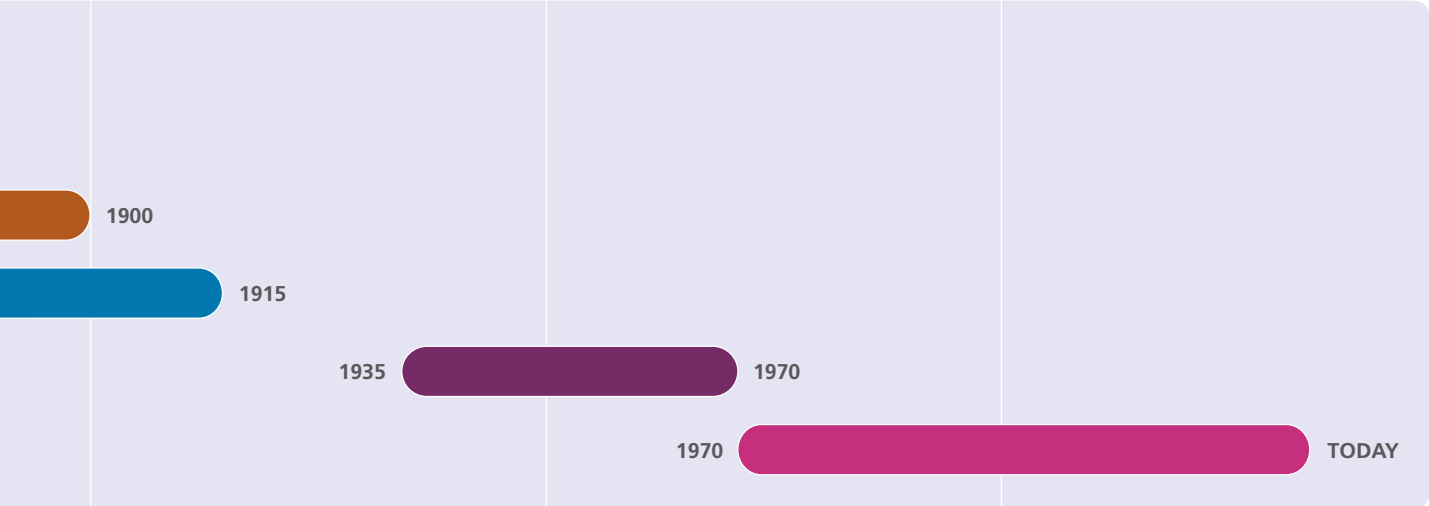

Federation

Fed

Art Deco

Art

Modern

Mod



AR39

Simpler, smaller versions of the Victorian styles. Featuring chains and bows and uniquely Australian designs incorporating flora and fauna patterns like waratahs, gumnuts, flannel flowers.



AR99

Bold, streamlined shapes with clean geometric lines. Patterns created using shapes such as triangles and diamonds replaced the excessive decoration of previous styles.



AR100

Bold geometric shapes again but of a more simplistic, plain style. Sharp straight lines with little or no pattern at all are the norm with this design style.



P12

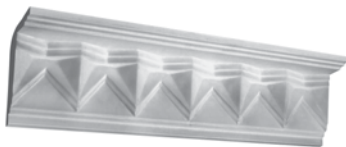

A223

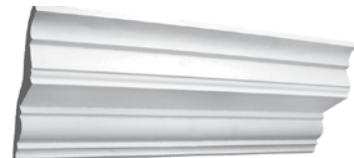

A149

Cornices



Pictured
A143 and A21 Cornice

A1 Fed

□ 50 mm

**A9** Fed

□ 105 mm

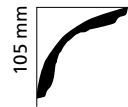
**A2** Fed

□ 70 mm

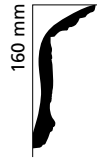
**A10** Geo

□ 110 mm

**A3** Fed

□ 105 mm

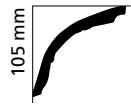
**A11** Geo

□ 140 mm

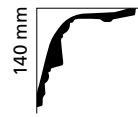
**A4** Col

□ 100 mm

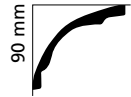
**A12** Art

□ 90 mm

**A5** Col

□ 230 mm

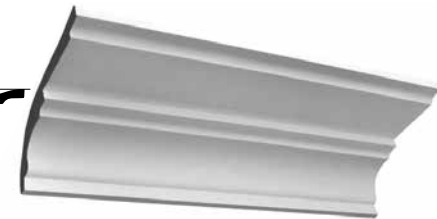
**A13** Art

□ 105 mm

**A6** Art

□ 90 mm

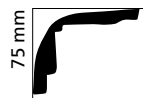
**A14** Art

□ 195 mm

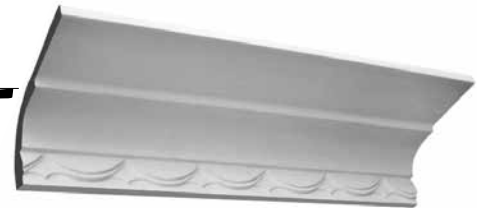
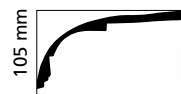
**A7** Art

□ 120 mm

**A15** Col

□ 130 mm

**A8** Fed

□ 90 mm

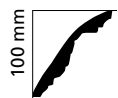
**A16** Col

□ 190 mm



ALL DIMENSIONS ARE APPROXIMATE

A17 *Col*

□ 90 mm

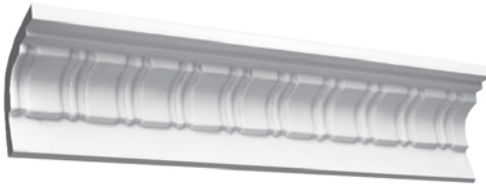
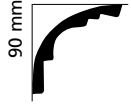

A24 *Vic*

□ 220 mm

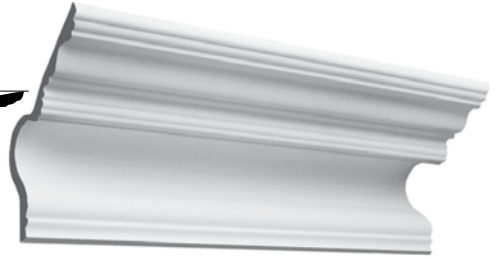

A18 *Col*

□ 105 mm

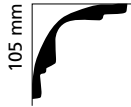

A25 *Vic*

□ 125 mm

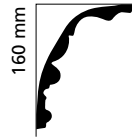

A19 *Vic*

□ 90 mm



A26 *Geo*

□ 100 mm

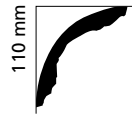

A20 *Vic*

□ 90 mm

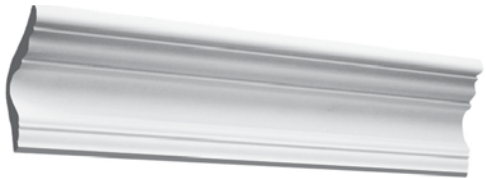

A27 *Col*

□ 185 mm



A21 *Vic*

□ 130 mm



A28 *Col*

□ 200 mm

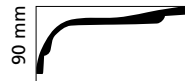

A22 *Vic*

□ 170 mm

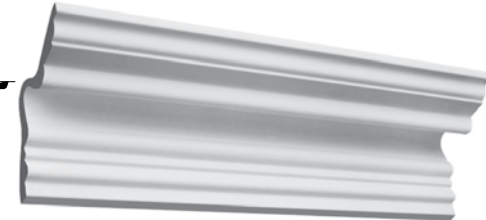

A29 *Mod*

□ 180 mm



A23 *Vic*

□ 200 mm



A30 *Col*

□ 60 mm



A31 *Fed*

□ 105 mm

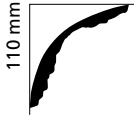
**A40** *Mod*

□ 140 mm

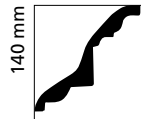
**A32** *Mod*

□ 75 mm

**A41** *Mod*

□ 140 mm

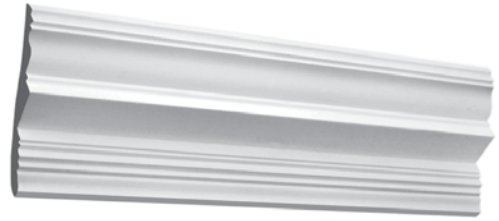
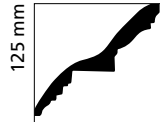
**A33** *Mod*

□ 75 mm

**A42** *Mod*

□ 140 mm

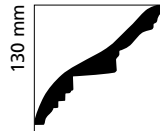
**A34** *Mod*

□ 100 mm

**A42** *Mod*

□ 140 mm

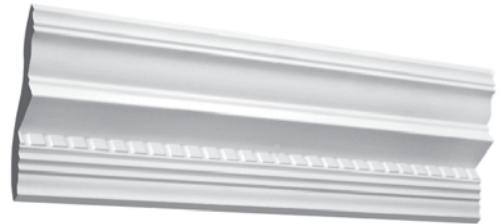
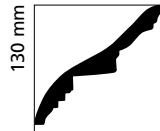
**A35** *Mod*

□ 110 mm

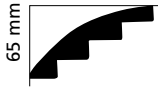
**A43** *Geo*

□ 170 mm

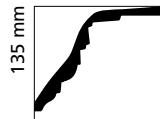
**A36** *Mod*

□ 95 mm

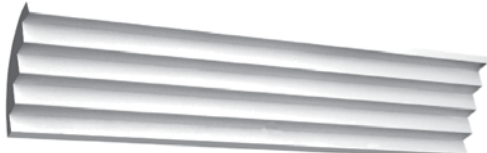
**A44** *Col*

□ 125 mm

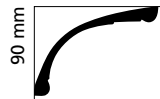
**A37** *Mod*

□ 110 mm

**A45** *Geo*

□ 125 mm

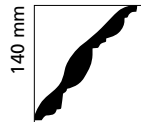
**A38** *Mod*

□ 90 mm

**A46** *Col*

□ 95 mm

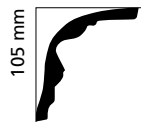
**A39** *Mod*

□ 90 mm

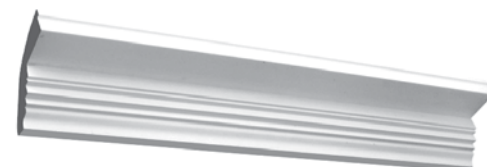

ALL DIMENSIONS ARE APPROXIMATE

A47 *Col*

□ 260 mm

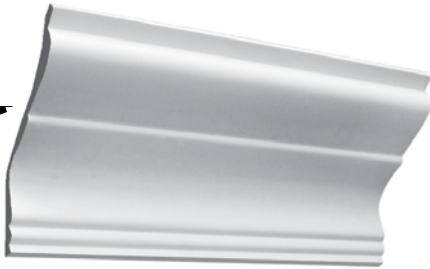

A48 *Fed*

□ 90 mm

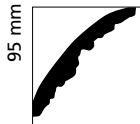

A49 *Fed*

□ 110 mm

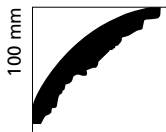

A50 *Col*

□ 95 mm

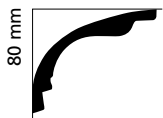

A51 *Col*

□ 170 mm

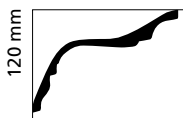

A52 *Col*

□ 220 mm

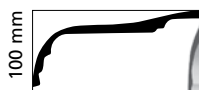

A53 *Fed*

□ 105 mm

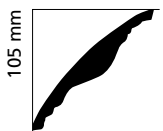

A54 *Fed*

□ 70 mm



A55 *Col*

□ 100 mm



A56 *Art*

□ 135 mm



A57 *Art*

□ 195 mm



A58 *Geo*

□ 50 mm



Available only in 3.6 m lengths

A59 *Col*

□ 75 mm

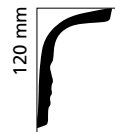

A60 *Col*

□ 185 mm



A61 *Fed*

□ 175 mm

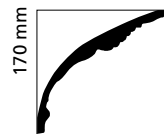

A62 *Col*

□ 115 mm

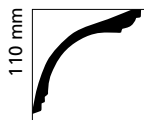

A70 *Mod*

□ 120 mm

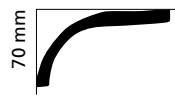

A63 *Col*

□ 95 mm

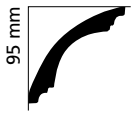

A71 *Mod*

□ 200 mm



A64 *Mod*

□ 70 mm



A72 *Mod*

□ 250 mm



A65 *Mod*

□ 105 mm



A73 *Art*

□ 105 mm

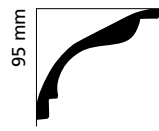

A66 *Mod*

□ 100 mm

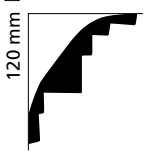

A74 *Art*

□ 340 mm



A67 *Col*

□ 100 mm



A75 *Col*

□ 215 mm



A68 *Col*

□ 155 mm



A76 *Geo*

□ 130 mm

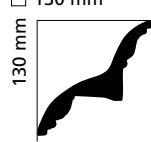

A69 *Col*

□ 220 mm

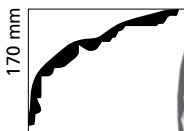

ALL DIMENSIONS ARE APPROXIMATE

A77 *Geo*

□ 180 mm

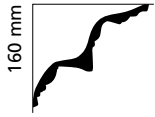

A83 *Fed*

□ 160 mm

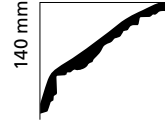

A78 *Col*

□ 350 mm

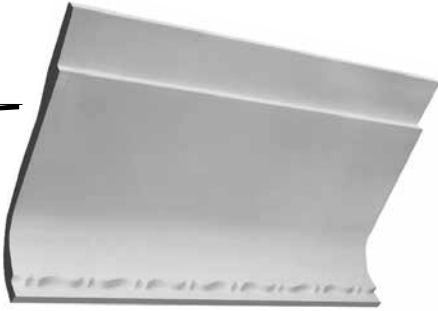
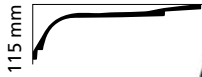

A84 *Mod*

□ 105 mm



A85 *Col*

□ 130 mm

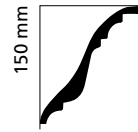

A79 *Vic*

□ 90 mm

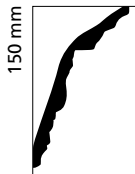

A86 *Fed*

□ 90 mm

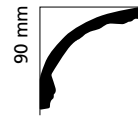

A80 *Geo*

□ 80 mm



A87 *Col*

□ 195 mm



A81 *Geo*

□ 140 mm

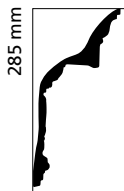

A88 *Mod*

□ 50 mm



Not available in 4.8 m lengths

A82 *Fed*

□ 105 mm



A89 *Vic*

□ 375 mm

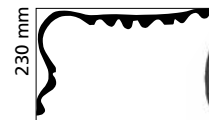

Not available in 4.8 m lengths

A90 *Mod*

□ 125 mm

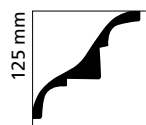

A97 *Col*

□ 215 mm

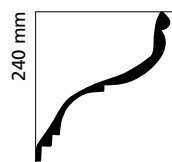

A91 *Mod*

□ 25 mm



Only available in 3.6 m lengths

A98 *Col*

□ 150 mm



A92 *Col*

□ 110 mm

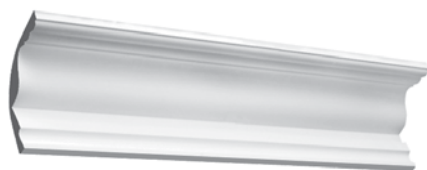

A99 *Vic*

□ 380 mm



Not available in 4.8 m lengths

A93 *Col*

□ 300 mm

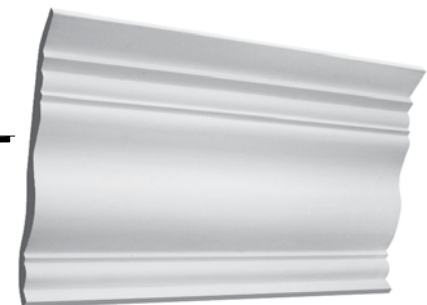
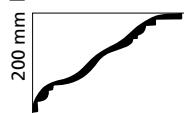

A100 *Geo*

□ 115 mm

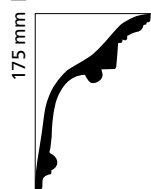

Only available in 4.2 m lengths

A94 *Vic*

□ 220 mm

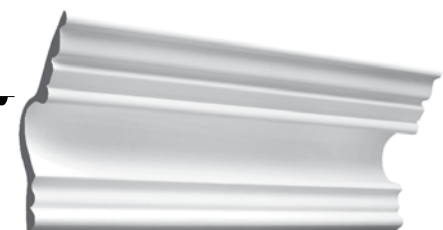
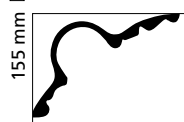

A101 *Geo*

□ 180 mm

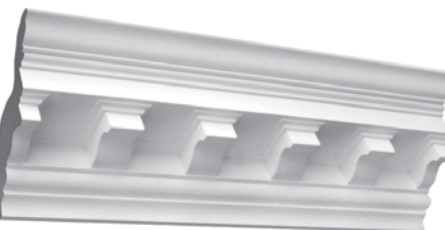
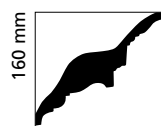

A95 *Col*

□ 265 mm



A102 *Geo*

□ 200 mm

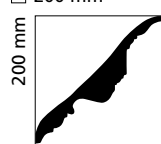

Only available in 3.6 m lengths

A96 *Mod*

□ 160 mm

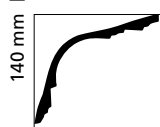

ALL DIMENSIONS ARE APPROXIMATE

A103 (Art)

□ 265 mm

110 mm

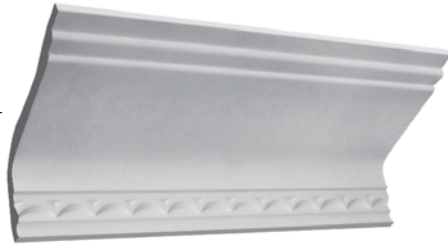
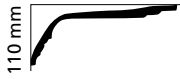
**A110** (Col)

□ 185 mm

105 mm

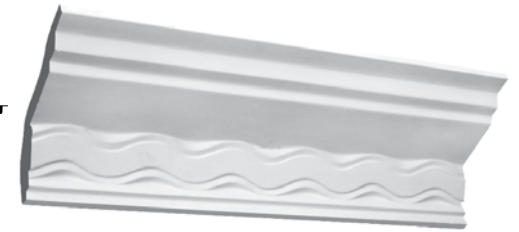
**A104** (Mod)

□ 190 mm

120 mm

**A111** (Art)

□ 115 mm

165 mm

**A105** (Col)

□ 130 mm

190 mm

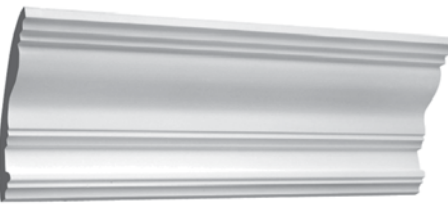
**A112** (Mod)

□ 80 mm

55 mm

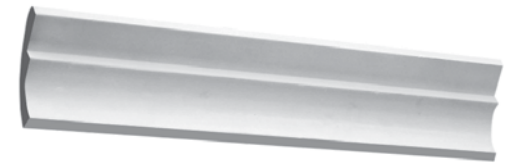
**A106** (Col)

□ 100 mm

105 mm

**A113** (Col)

□ 265 mm

150 mm

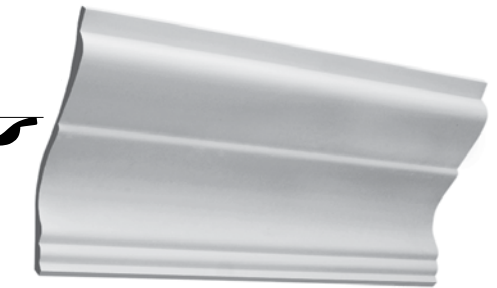
**A107** (Art)

□ 80 mm

80 mm

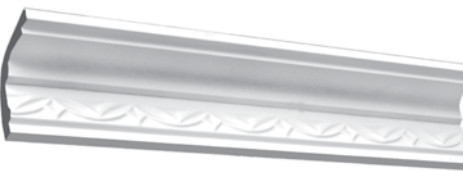
**A114** (Fed)

□ 155 mm

150 mm

**A108** (Art)

□ 190 mm

120 mm

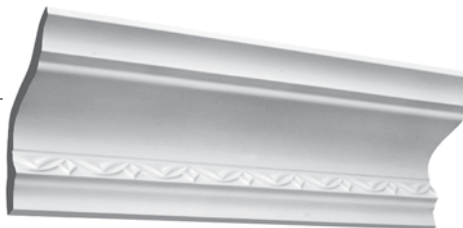
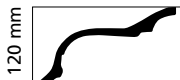
**A115** (Mod)

□ 180 mm

100 mm

**A109** (Col)

□ 145 mm

70 mm

**A116** (Art)

□ 190 mm

85 mm



A117 *Mod*

□ 250 mm

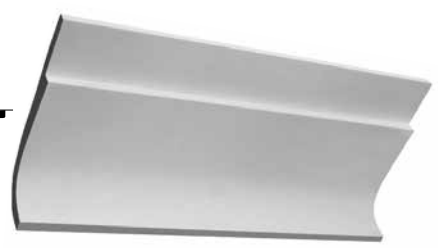

A125 *Mod*

□ 90 mm



A118 *Fed*

□ 50 mm



A126 *Mod*

□ 160 mm

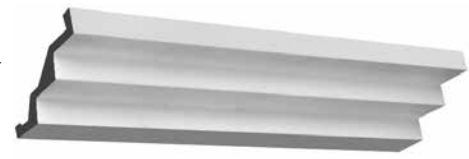

A119 *Col*

□ 200 mm

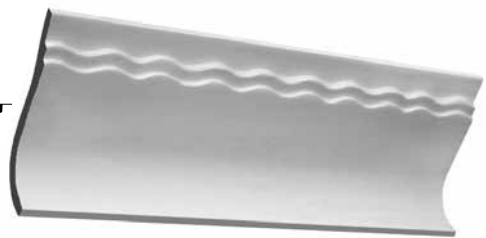
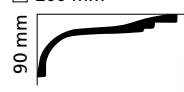

A127 *Art*

□ 65 mm

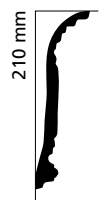

A120 *Mod*

□ 170 mm

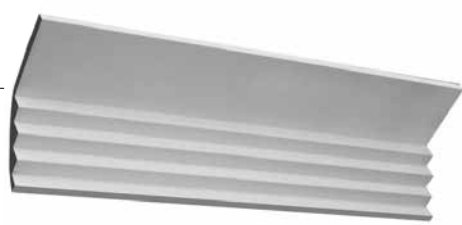
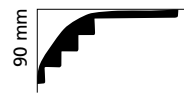

A128 *Geo*

□ 110 mm

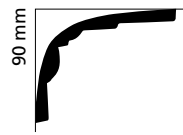

A121 *Geo*

□ 230 mm

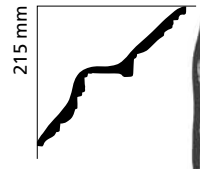

A129 *Fed*

□ 200 mm

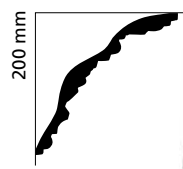

A122 *Mod*

□ 125 mm

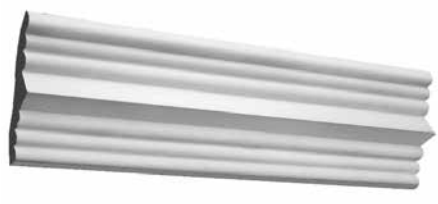
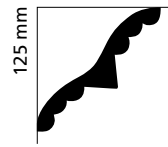

A130 *Geo*

□ 110 mm

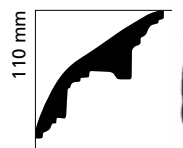

A123 *Mod*

□ 90 mm

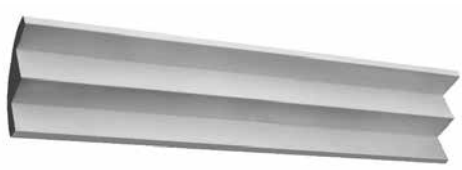
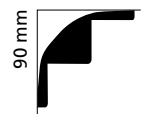

A131 *Geo*

□ 150 mm

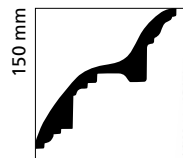

A124 *Mod*

□ 90 mm

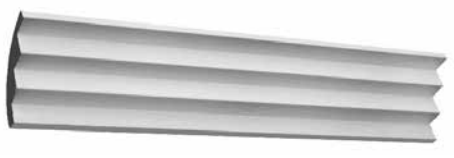
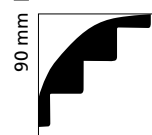

A132 *Fed*

□ 70 mm

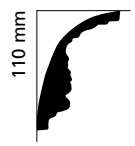

ALL DIMENSIONS ARE APPROXIMATE

A133 *Col*

□ 225 mm

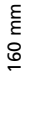

A140 *Col*

□ 190 mm

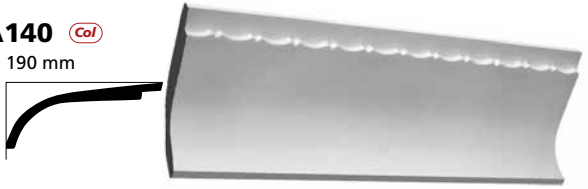

A134 *Col*

□ 100 mm



A141 *Mod*

□ 180 mm



Only available in 3.6 m lengths

A135 *Fed*

□ 125 mm

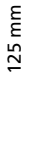

A142 *Mod*

□ 200 mm



Only available in 3.6 m lengths

A136 *Fed*

□ 185 mm

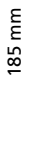

A143 *Vic*

□ 195 mm

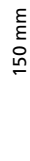

A137 *Fed*

□ 110 mm



A144 *Vic*

□ 290 mm

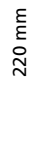

A138 *Fed*

□ 190 mm



A145 *Mod*

□ 110 mm



Only available in 4.2 m lengths

A139 *Fed*

□ 200 mm

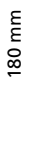

A146 *Geo*

□ 275 mm

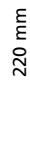

Only available in 3.6 m lengths



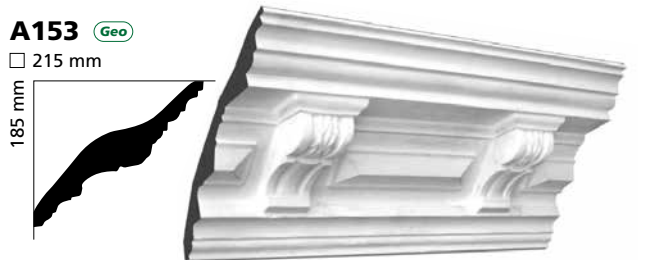
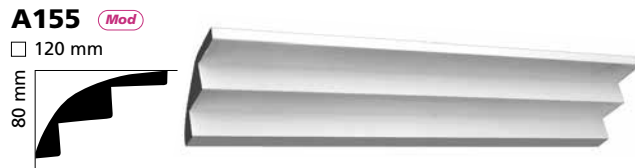
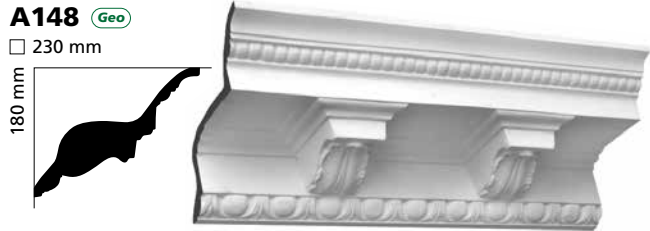
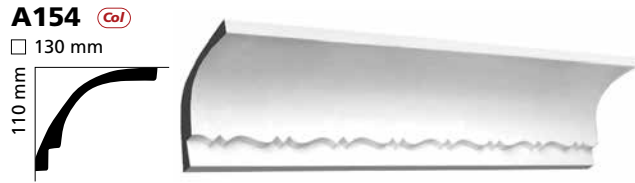

A161 *Art*

□ 130 mm

275 mm

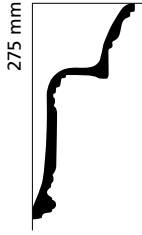
**A166** *Vic*

□ 175 mm

150 mm

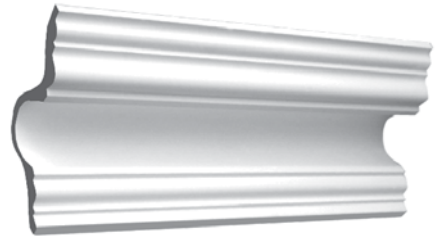
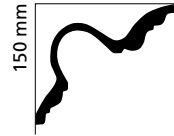
**A162** *Col*

□ 355 mm

110 mm

**A167** *Col*

□ 135 mm

120 mm

**A163** *Mod*

□ 230 mm

115 mm

**A168** *Mod*

□ 90 mm

90 mm

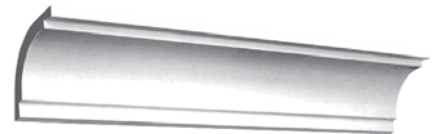
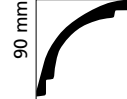
**A164** *Vic*

□ 250 mm

170 mm

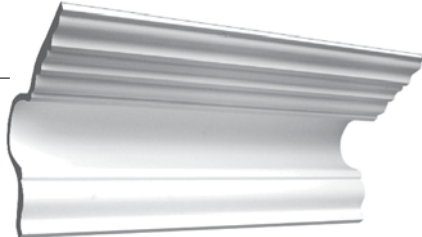
**A169** *Vic*

□ 325 mm

220 mm

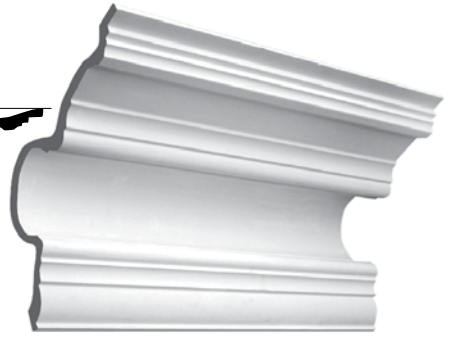
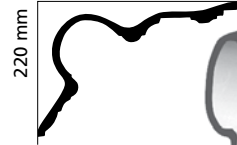
**A165** *Vic*

□ 330 mm

170 mm

**A170** *Vic*

□ 245 mm

170 mm

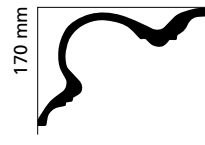
**A165-A / A165-B** *Vic*

□ 330 mm

170 mm

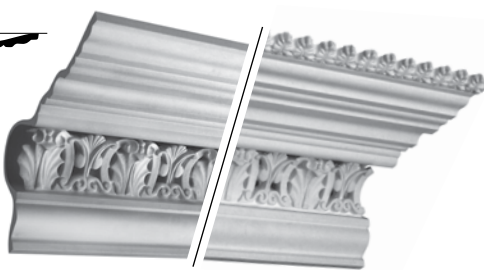
**A171** *Vic*

□ 285 mm

200 mm

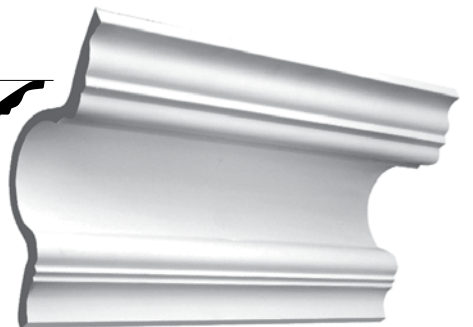
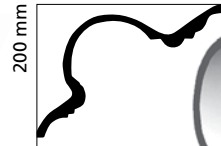

Using PA1 and PA2 Plaster Accessories

A172 *Mod*

□ 205 mm



A180 *Vic*

□ 220 mm



A173 *Mod*

□ 350 mm



A181 *Art*

□ 100 mm



A174 *Mod*

□ 100 mm



A182 *Geo*

□ 175 mm



A175 *Art*

□ 190 mm

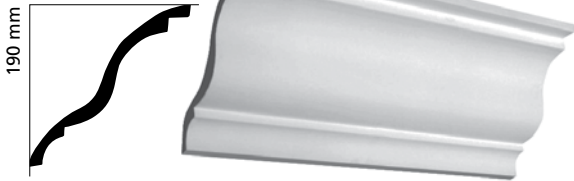

A183 *Geo*

□ 115 mm



A176 *Mod*

□ 115 mm



A184 *Art*

□ 90 mm



A177 *Art*

□ 160 mm



A185 *Mod*

□ 185 mm



A178 *Col*

□ 95 mm



A186 *Mod*

□ 65 mm



A179 *Geo*

□ 105 mm



A187 *Col*

□ 185 mm



ALL DIMENSIONS ARE APPROXIMATE

A188 *Col*

□ 260 mm

110 mm

**A196** *Art*

□ 75 mm

90 mm

**A189** *Col*

□ 340 mm

120 mm

**A197** *Art*

□ 335 mm

110 mm

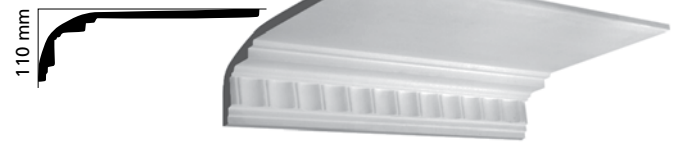
**A190** *Fed*

□ 140 mm

180 mm

**A198** *Col*

□ 270 mm

110 mm

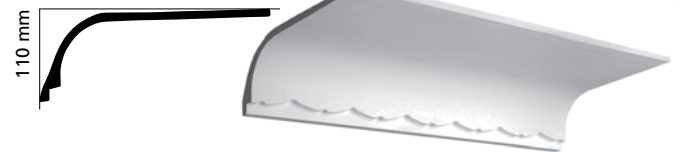
**A191** *Fed*

□ 160 mm

165 mm

**A199** *Col*

□ 355 mm

110 mm

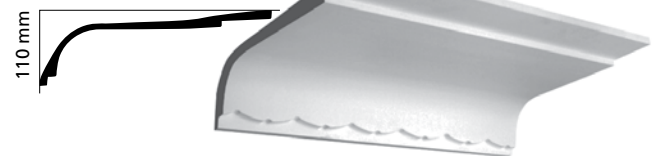
**A192** *Fed*

□ 160 mm

160 mm

**A200** *Art*

□ 140 mm

180 mm

**A193** *Art*

□ 120 mm

140 mm

**A201** *Art*

□ 100 mm

130 mm

**A194** *Art*

□ 165 mm

105 mm

**A202** *Fed*

□ 70 mm

85 mm

**A195** *Art*

□ 285 mm

100 mm

**A203** *Fed*

□ 110 mm

120 mm



A204 *Mod*

□ 295 mm

**A212** *Art*

□ 390 mm

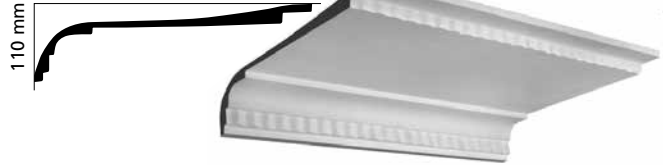
**A205** *Mod*

□ 385 mm

**A213** *Mod*

□ 40 mm



Not available in 4.8 m length

A214 *Geo*

□ 40 mm



Only available in 4 m length

A206 *Col*

□ 305 mm

**A215** *Geo*

□ 250 mm

**A207** *Col*

□ 350 mm

**A216** *Vic*

□ 300 mm

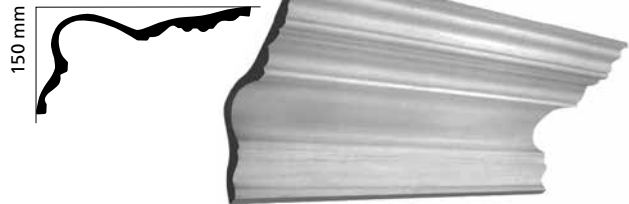
**A208** *Fed*

□ 180 mm

**A217** *Vic*

□ 90 mm

**A209** *Mod*

□ 85 mm

**A218** *Col*

□ 245 mm

**A210** *Mod*

□ 165 mm

**A219** *Col*

□ 310 mm

**A211** *Art*

□ 80 mm



ALL DIMENSIONS ARE APPROXIMATE

A220 Col

□ 350 mm

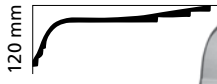
**A227** Geo

□ 135 mm

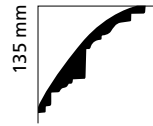
**A221** Art

□ 125 mm

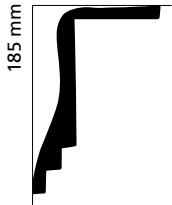
**A228** Vic

□ 150 mm

**A222** Art

□ 140 mm

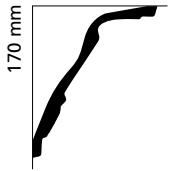
**A229** Col

□ 125 mm

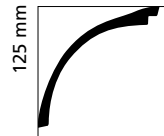
**A223** Art

□ 100 mm

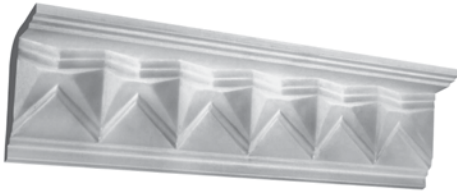
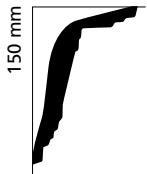
**A230** Art

□ 100 mm

**A224** Col

□ 150 mm

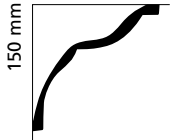
**A231** Col

□ 150 mm

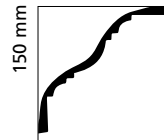
**A225** Vic

□ 190 mm

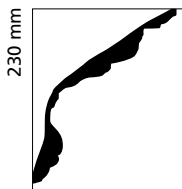
**A232** Col

□ 90 mm

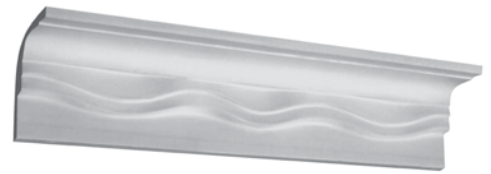
**A226** Geo

□ 100 mm

**A233** Art

□ 260 mm

**A234** Fed

□ 85 mm



Only available in 3.6 m lengths

A235 *Fed*

□ 125 mm

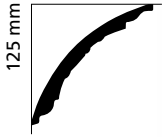
**A244** *Col*

□ 130 mm

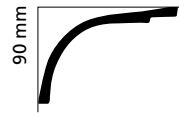
**A236** *Art*

□ 115 mm

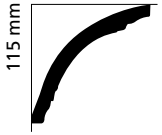
**A245** *Art*

□ 80 mm

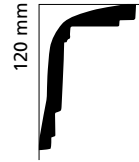
**A237** *Col*

□ 125 mm

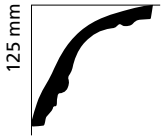
**A246** *Mod*

□ 90 mm

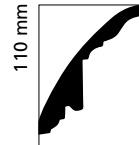
**A238** *Col*

□ 80 mm

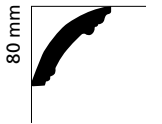
**A247** *Mod*

□ 130 mm

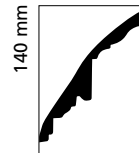
**A239** *Col*

□ 85 mm

**A248** *Art*

□ 125 mm

**A240** *Art*

□ 120 mm

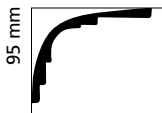
**A249** *Vic*

□ 140 mm

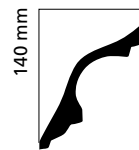
**A241** *Col*

□ 90 mm

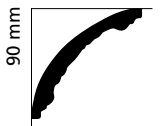
**A250** *Vic*

□ 90 mm

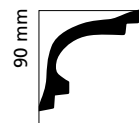
**A242** *Fed*

□ 90 mm

**A251** *Geo*

□ 85 mm

**A243** *Col*

□ 85 mm

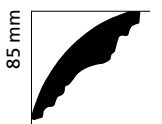

ALL DIMENSIONS ARE APPROXIMATE

A252 *Fed*

□ 240 mm

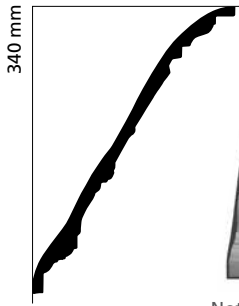

Not available in 4.8 m lengths

A259 *Col*

□ 160 mm

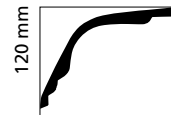
**A260** *Vic*

□ 100 mm

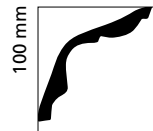
**A261** *Col*

□ 105 mm

**A262** *Mod*

□ 85 mm

**A263** *Mod*

□ 180 mm

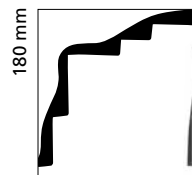
**A264** *Art*

□ 430 mm

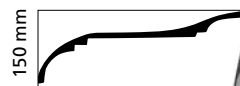
**A265** *Fed*

□ 90 mm

**A266** *Fed*

□ 90 mm

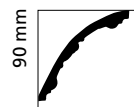
**A267** *Fed*

□ 130 mm

**A253** *Art*

□ 115 mm

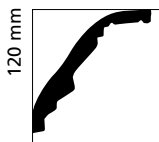
**A254** *Fed*

□ 150 mm

**A255** *Art*

□ 145 mm

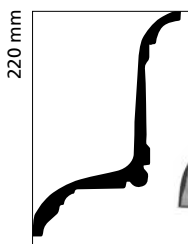
**A256** *Col*

□ 155 mm

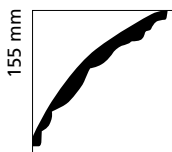
**A257** *Geo*

□ 120 mm

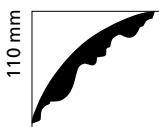
**A258** *Art*

□ 230 mm



A268 *Vic*

□ 130 mm

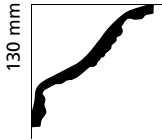

A276 *Mod*

□ 155 mm



A269 *Vic*

□ 160 mm



A277 *Geo*

□ 160 mm

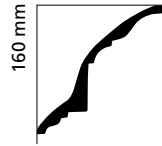

A270 *Mod*

□ 120 mm

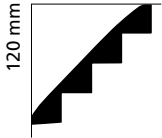

A278 *Geo*

□ 210 mm

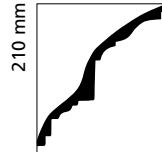

A271 *Mod*

□ 70 mm



A279 *Col*

□ 50 mm



Only available in 3m lengths

A272 *Mod*

□ 140 mm



A280 *Fed*

□ 115 mm

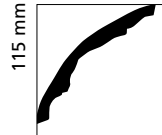

A273 *Vic*

□ 170 mm

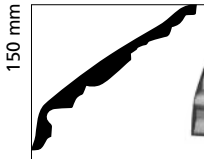

A281 *Fed*

□ 200 mm

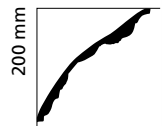

A274 *Fed*

□ 180 mm

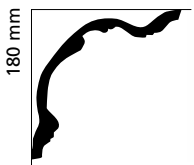

Not available in 4.8 m lengths

A282 *Vic*

□ 110 mm



A275 *Art*

□ 125 mm

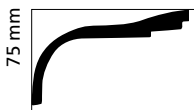

A283 *Mod*

□ 140 mm

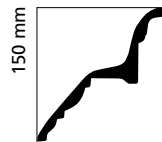

ALL DIMENSIONS ARE APPROXIMATE

A284 (Art)

□ 80 mm

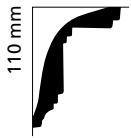

A292 (Col)

□ 305 mm



A285 (Col)

□ 190 mm



A293 (Art)

□ 230 mm



A286 (Col)

□ 270 mm



A294 (Geo)

□ 120 mm

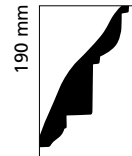

Only available in 3.6m length

A287 (Col)

□ 345 mm



A295 (Geo)

□ 370 mm

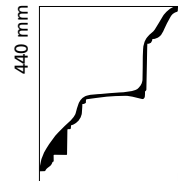

Only available in 3.6m length

A288 (Col)

□ 135 mm

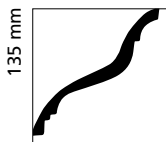

A296 (Vic)

□ 215 mm

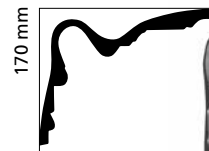

A289 (Fed)

□ 170 mm

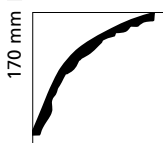

A297 (Col)

□ 270 mm



A290 (Col)

□ 85 mm

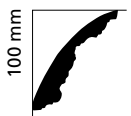

A298 (Col)

□ 180 mm

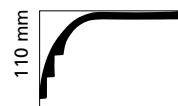

A291 (Col)

□ 210 mm



A299 Col

□ 370 mm



A305 Art

□ 200 mm

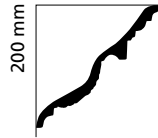

A300 Col

□ 390 mm



A306 Fed

□ 120 mm



A301 Geo

□ 155 mm

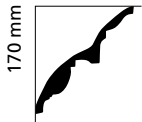

A307 Fed

□ 130 mm

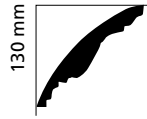

A302 Vic

□ 280 mm

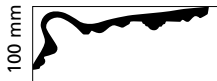

A308 Mod

□ 65 mm



Only available in 4.2 m length

A303 Vic

□ 470 mm



Only available in 3.6 m length

A309 Mod

□ 105 mm



Match for CSR shadow set
Only available on 4.2 m length

A310 Fed

□ 115 mm

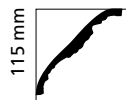

A304 Geo

□ 350 mm

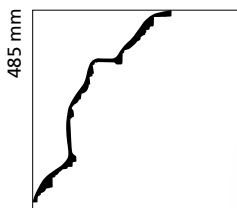

Only available in 3.6 m length

A311 Geo

□ 140 mm

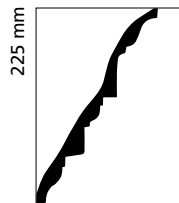

A312 Geo

□ 220 mm

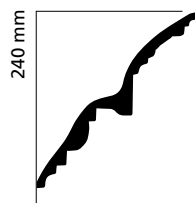

ALL DIMENSIONS ARE APPROXIMATE



A313 *Vic*

□ 150 mm

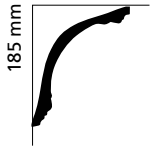

A322 *Col*

□ 90 mm

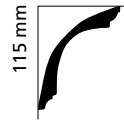

A314 *Geo*

□ 130 mm

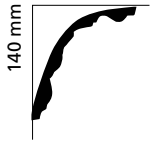

A323 *Mod*

□ 120 mm

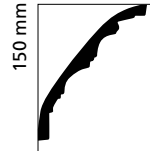

A315 *Col*

□ 420 mm

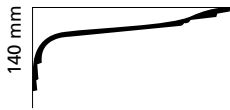

A324 *Mod*

□ 150 mm



A316 *Art*

□ 120 mm

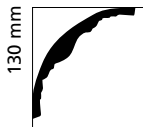

A325 *Col*

□ 125 mm

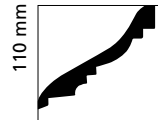

A317 *Col*

□ 55 mm



Only available in 3.6 m length

A326 *Col*

□ 80 mm

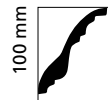

A318 *Mod*

□ 90 mm



A327 *Vic*

□ 130 mm



A319 *Mod*

□ 90 mm

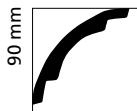

A328 *Vic*

□ 150 mm



A320 *Mod*

□ 80 mm

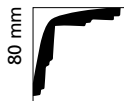

A329 *Vic*

□ 150 mm



A321 *Mod*

□ 50 mm



Not available in 4.8 m length

A330 *Vic*

□ 220 mm



A331 *(Vic)*

□ 200 mm

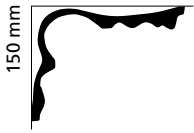

A341 *(Col)*

□ 100 mm

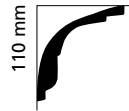

A332 *(Vic)*

□ 240 mm



A342 *(Col)*

□ 130 mm



A333 *(Art)*

□ 235 mm

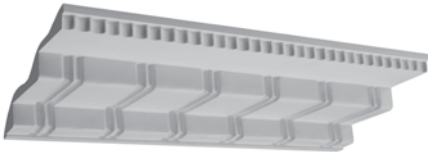

A343 *(Fed)*

□ 120 mm

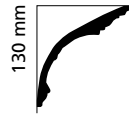

A334 *(Col)*

□ 190 mm



A344 *(Col)*

□ 70 mm



A335 *(Col)*

□ 235 mm

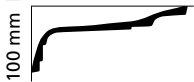

A345 *(Art)*

□ 70 mm



A336 *(Mod)*

□ 115 mm



A346 *(Mod)*

□ 75 mm



Match for CSR Jazz

A337 *(Geo)*

□ 95 mm



A347 *(Mod)*

□ 85 mm



Match for CSR Classic

A338 *(Mod)*

□ 120 mm



A348 *(Mod)*

□ 350 mm



300 mm radius. Available in 3.0 lengths only. Recessed edges both sides to be set

A339 *(Mod)*

□ 65 mm



Not available in 4.8m lengths

A349 *(Mod)*

□ 165 mm



A340 *(Mod)*

□ 60 mm



Not available in 4.8m lengths

ALL DIMENSIONS ARE APPROXIMATE



A350 *Mod*

□ 145 mm

195 mm

**A351** *Mod*

□ 135 mm

170 mm

**P1** *Col*

□ 90 mm

90 mm

**P11** *Col*

□ 150 mm

125 mm

**P2** *Fed*

□ 90 mm

90 mm

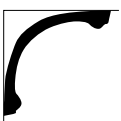
**P12** *Fed*

□ 150 mm

125 mm

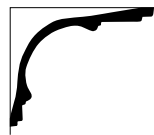
**P3** *Fed*

□ 90 mm

90 mm

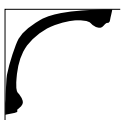
**P13** *Fed*

□ 150 mm

125 mm

**P4** *Fed*

□ 90 mm

90 mm

**P14** *Fed*

□ 150 mm

125 mm

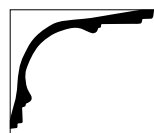
**P5** *Geo*

□ 90 mm

90 mm

**P15** *Geo*

□ 150 mm

125 mm

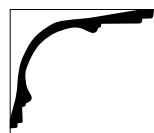
**P6** *Col*

□ 90 mm

90 mm

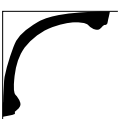
**P16** *Col*

□ 145 mm

120 mm

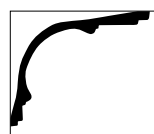

Trying to match a cornice?

You can print out a 1:1 end profile of every cornice helping you to match or confirm a match to any existing cornice.

Check out our Instock Range at www.allplasta.com.au



Ceiling Centres



Pictured
AR74



AR1 Fed
 ⊖ 650 mm DIAMETER
 70 mm CENTRE DIAMETER



AR2 Fed
 ⊖ 550 mm DIAMETER
 70 mm CENTRE DIAMETER



AR3 Geo
 ⊖ 650 mm DIAMETER
 70 mm CENTRE DIAMETER



AR4 Geo
 ⊖ 550 mm DIAMETER
 70 mm CENTRE DIAMETER



AR5 Fed
 ⊖ 650 mm DIAMETER
 70 mm CENTRE DIAMETER



AR6 Fed
 ⊖ 550 mm DIAMETER
 70 mm CENTRE DIAMETER



AR7 Vic
 ⊖ 550 mm DIAMETER
 85 mm CENTRE DIAMETER



AR8 Art
 ⊖ 550 mm DIAMETER
 30 mm CENTRE DIAMETER



AR9 Col
 ⊖ 250 mm DIAMETER
 30 mm CENTRE DIAMETER



AR10 Fed
 ⊖ 500 mm DIAMETER
 20 mm CENTRE DIAMETER



AR11 Col
 ⊖ 610 mm DIAMETER
 40 mm CENTRE DIAMETER



AR12 Geo
 ⊖ 580 mm DIAMETER
 110 mm CENTRE DIAMETER TO PATTERN



AR13 Geo
 ⊖ 600 mm DIAMETER
 100 mm CENTRE DIAMETER



AR14 Vic
 ⊖ 650 mm DIAMETER
 110 mm CENTRE DIAMETER



AR15 Vic
 ⊖ 700 mm DIAMETER
 110 mm CENTRE DIAMETER



AR16 Col
 ⊖ 620 mm DIAMETER
 40 mm CENTRE DIAMETER



AR17 Fed
 ⊖ 610 mm DIAMETER
 90 mm CENTRE DIAMETER



AR18 Geo
 ⊖ 620 mm DIAMETER
 95 mm CENTRE DIAMETER



AR19 / AR19-V Vic
 ⊖ 540 mm DIAMETER
 Available vented or un-vented



AR20 Col
 ⊖ 620 mm DIAMETER
 90 mm CENTRE DIAMETER



AR21 Fed
 ⊖ 650 mm DIAMETER
 70 mm CENTRE DIAMETER



AR22 Col
 ⊖ 432 mm DIAMETER
 35 mm CENTRE DIAMETER



AR23 Vic
 ⊖ 432 mm DIAMETER
 30 mm CENTRE DIAMETER



AR24 Geo
 ⊖ 510 mm DIAMETER
 25 mm CENTRE DIAMETER

ALL DIMENSIONS ARE APPROXIMATE





AR25 **(Vic)**
 ⊖ 870 mm DIAMETER
 110 mm CENTRE DIAMETER



AR26 **(Vic)**
 ⊖ 360 mm DIAMETER
 30 mm CENTRE DIAMETER

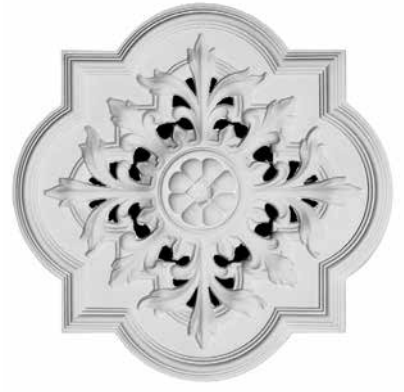

AR27 / AR27-V **(Art)**
 ⊖ 750 mm DIAMETER
 45 mm CENTRE DIAMETER
 Available vented or un-vented



AR28 **(Col)**
 ⊖ 710 mm DIAMETER
 30 mm CENTRE DIAMETER



AR29 **(Geo)**
 ⊖ 520 mm DIAMETER
 40 mm CENTRE DIAMETER



AR30 **(Fed)**
 ⊖ 590 mm DIAMETER
 90 mm CENTRE DIAMETER

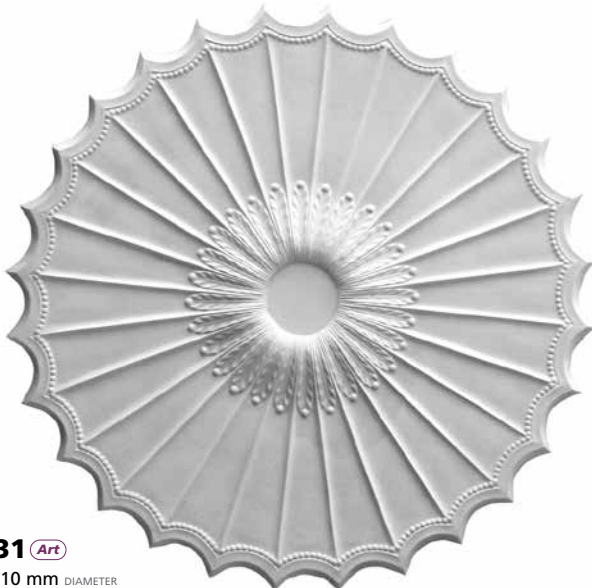

AR31 **(Art)**
 ⊖ 1010 mm DIAMETER
 120 mm CENTRE DIAMETER



AR32 **(Col)**
 ⊖ 1100 mm DIAMETER
 110 mm CENTRE DIAMETER



AR33 (Col)
 ⊖ 550 mm DIAMETER
 ⊖ 135 mm CENTRE DIAMETER



AR34 (Fed)
 ⊖ 550 mm DIAMETER
 ⊖ 135 mm CENTRE DIAMETER



AR35 (Fed)
 ⊖ 550 mm DIAMETER
 ⊖ 135 mm CENTRE DIAMETER



AR36 (Fed)
 ⊖ 550 mm DIAMETER
 ⊖ 135 mm CENTRE DIAMETER



AR37 (Geo)
 ⊖ 550 mm DIAMETER
 ⊖ 135 mm CENTRE DIAMETER



AR38 (Col)
 ⊖ 650 mm DIAMETER
 ⊖ 135 mm CENTRE DIAMETER



AR39 (Fed)
 ⊖ 650 mm DIAMETER
 ⊖ 135 mm CENTRE DIAMETER



AR40 (Fed)
 ⊖ 650 mm DIAMETER
 ⊖ 135 mm CENTRE DIAMETER



AR41 (Fed)
 ⊖ 650 mm DIAMETER
 ⊖ 135 mm CENTRE DIAMETER



AR42 (Geo)
 ⊖ 650 mm DIAMETER
 ⊖ 135 mm CENTRE DIAMETER



AR43 (Art)
 ⊖ 570 mm DIAMETER
 ⊖ 95 mm CENTRE DIAMETER



AR44 (Fed)
 ⊖ 870 mm DIAMETER
 ⊖ 95 mm CENTRE DIAMETER

ALL DIMENSIONS ARE APPROXIMATE

**AR45** *Fed*

⊖ 870 mm DIAMETER
 ⊖ 95 mm CENTRE DIAMETER

**AR46** *Geo*

⊖ 750 mm DIAMETER
 ⊖ 30 mm CENTRE DIAMETER

**AR47** *Col*

⊖ 445 mm DIAMETER
 ⊖ 35 mm CENTRE DIAMETER

**AR48** *Art*

□ 700 mm x 450 mm
 ⊖ 100 mm CENTRE DIAMETER

**AR49** *Vic*

⊖ 750 mm DIAMETER
 ⊖ 65 mm CENTRE DIAMETER

**AR50** *Art*

□ 1240 x 945 mm
 ⊖ 100 x 80 mm CENTRE

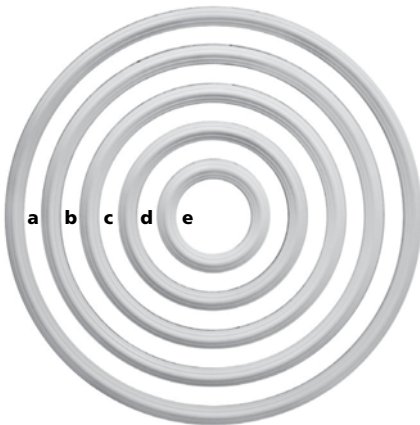
**AR51 (Plaster Rings)** *Col*

⊖ **a** 1000 mm INSIDE DIAMETER ⊖ **c** 600 mm INSIDE DIAMETER ⊖ **e** 200 mm INSIDE DIAMETER
 ⊖ **b** 800 mm INSIDE DIAMETER ⊖ **d** 400 mm INSIDE DIAMETER

(A534 Strip matches Plaster Ring Profile)

**AR53** *Vic*

□ 1960 mm x 1280 mm
 Also as border only



AR52 *Col*
 ⊖ 300 mm DIAMETER
 90 mm CENTRE DIAMETER



AR54 *Col*
 □ 510 mm x 510 mm



AR55 *Geo*
 ⊖ 800 mm DIAMETER
 60 mm CENTRE DIAMETER



AR56 *Vic*
 ⊖ 760 mm DIAMETER
 110 mm CENTRE DIAMETER



AR57 *Geo*
 ⊖ 630 mm DIAMETER
 20 mm CENTRE DIAMETER



AR58 *Vic*
 ⊖ 570 mm DIAMETER
 20 mm CENTRE DIAMETER



AR59 *Vic*
 ⊖ 760 mm DIAMETER
 45 mm CENTRE DIAMETER



AR60 / AR60-V *Vic*
 ⊖ 630 mm DIAMETER
 120 mm CENTRE DIAMETER
 Available vented or un-vented



AR61 *Art*
 ⊖ 550 mm DIAMETER
 40 mm CENTRE DIAMETER



AR62 *Col*
 ⊖ 330 mm DIAMETER
 20 mm CENTRE DIAMETER



AR63 *Geo*
 □ 520 mm x 520 mm
 ⊖ 70 mm CENTRE DIAMETER



AR64 *Mad*
 ⊖ 600 mm DIAMETER
 130 mm CENTRE DIAMETER

ALL DIMENSIONS ARE APPROXIMATE



AR65 Geo
 ⊖ 380 mm DIAMETER
 ⊖ 50 mm CENTRE DIAMETER



AR66 Vic
 ⊖ 730 mm DIAMETER
 ⊖ 65 mm CENTRE DIAMETER



AR67 Art
 □ 1180 x 700 mm
 ⊖ 70 mm CENTRE DIAMETER

AR68 Vic

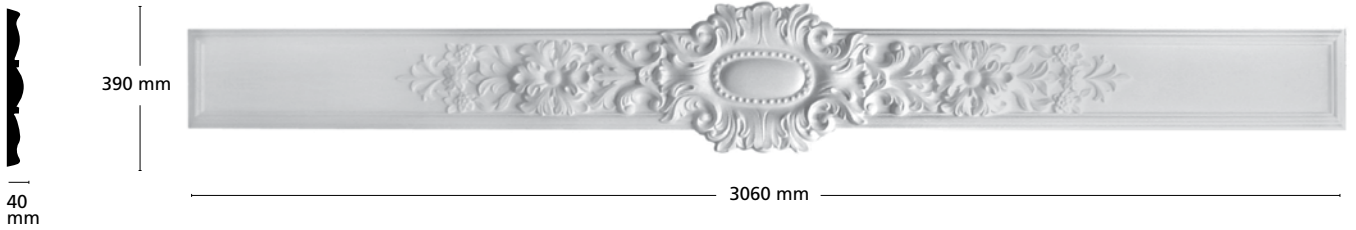

AR69 Col

- INCLUDES:
- 4 STRIP CORNERS
- 4 KEYSTONES
- EXTENSION AS44

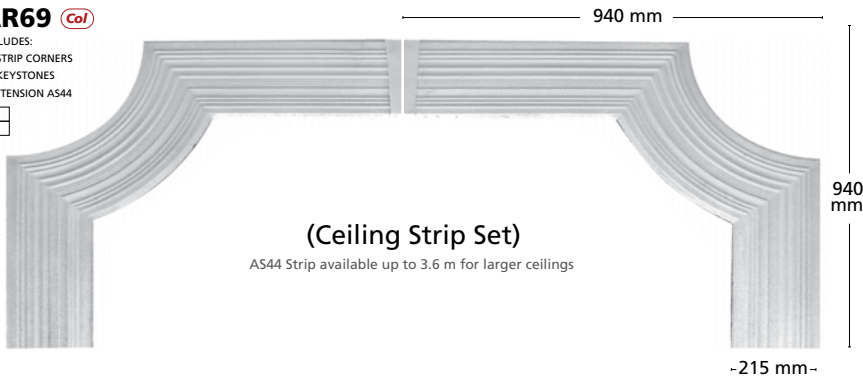

AR70 Col
 ⊖ 300 mm DIAMETER
 ⊖ 40 mm CENTRE DIAMETER



AR71 / AR71-V Vic
 ⊖ 600 mm DIAMETER
 ⊖ 60 mm CENTRE DIAMETER
 Available vented or un-vented



AR72 / AR72-V Vic
 ⊖ 700 mm DIAMETER
 ⊖ 85 mm CENTRE DIAMETER
 Available vented or un-vented



AR73 / AR73-V Vic
 ⊖ 1000 mm DIAMETER
 ⊖ 90 mm CENTRE DIAMETER
 Available vented or un-vented



**AR74 / AR74-V** (Vic)

⊖ 1200 mm DIAMETER
 ⊖ 90 mm CENTRE DIAMETER

Available vented or un-vented

**AR75** (Fed)

⊖ 780 mm DIAMETER
 ⊖ 135 mm CENTRE DIAMETER

**AR76** (Fed)

⊖ 470 mm DIAMETER
 ⊖ 55 mm CENTRE DIAMETER

**AR77** (Geo)

⊖ 600 mm DIAMETER
 ⊖ 50 mm CENTRE DIAMETER

**AR78** (Col)

⊖ 400 mm DIAMETER
 ⊖ 35 mm CENTRE DIAMETER

**AR79 / AR79-V** (Vic)

⊖ 870 mm DIAMETER
 ⊖ 50 mm CENTRE DIAMETER

Available vented or un-vented

**AR80** (Fed)

⊖ 460 mm DIAMETER
 ⊖ 100 mm CENTRE DIAMETER

**AR81** (Vic)

⊖ 340 mm DIAMETER
 ⊖ 20 mm CENTRE DIAMETER

**AR82** (Vic)

⊖ 250 mm DIAMETER
 ⊖ 50 mm CENTRE DIAMETER

**AR83** (Fed)

⊖ 930 mm DIAMETER
 ⊖ 160 mm CENTRE DIAMETER

**AR84** (Vic)

⊖ 340 mm DIAMETER
 ⊖ 50 mm CENTRE DIAMETER

**AR85** (Vic)

⊖ 780 mm DIAMETER
 ⊖ 65 mm CENTRE DIAMETER

ALL DIMENSIONS ARE APPROXIMATE

**AR86** Fed

□ 1000 mm x 560 mm
 ⊖ 85 mm CENTRE DIAMETER

**AR87** Fed

□ 780 mm x 580 mm
 ⊖ 75 mm CENTRE DIAMETER

**AR88** Vic

□ 720 mm x 570 mm
 ⊖ 70 mm CENTRE DIAMETER

**AR89** Fed

⊖ 610 mm DIAMETER
 ⊖ 110 mm CENTRE DIAMETER

**AR90** Fed

⊖ 610 mm DIAMETER
 ⊖ 110 mm CENTRE DIAMETER

**AR91** Fed

⊖ 610 mm DIAMETER
 ⊖ 110 mm CENTRE DIAMETER

**AR92** Col

⊖ 610 mm DIAMETER
 ⊖ 100 mm CENTRE DIAMETER

**AR93** Fed

⊖ 600 mm DIAMETER
 ⊖ 110 mm CENTRE DIAMETER

**AR94** Fed

⊖ 600 mm DIAMETER
 ⊖ 110 mm CENTRE DIAMETER

**AR95** Fed

⊖ 610 mm DIAMETER
 ⊖ 110 mm CENTRE DIAMETER

**AR96 / AR96-V** Vic

⊖ 460 mm DIAMETER
 ⊖ 60 mm CENTRE DIAMETER
 Available vented or un-vented

**AR97 / AR97-V** Art

⊖ 590 mm DIAMETER
 ⊖ 30 mm CENTRE DIAMETER
 Available vented or un-vented



AR98 *Mod*
 ⊖ 550 mm DIAMETER
 ⊖ 170 mm CENTRE DIAMETER



AR99 *Art*
 ⊖ 690 mm DIAMETER
 □ 90 mm x 90 mm CENTRE



AR100 *Mod*
 ⊖ 600 mm DIAMETER
 ⊖ 130 mm CENTRE DIAMETER



AR101 / AR101-V *Vic*
 ⊖ 760 mm DIAMETER
 ⊖ 60 mm CENTRE DIAMETER
 Available vented or un-vented



AR102 *Col*
 ⊖ 280 mm DIAMETER
 ⊖ 100 mm CENTRE DIAMETER



AR103 *Geo*
 ⊖ 480 mm DIAMETER
 ⊖ 30 mm CENTRE DIAMETER



AR104 *Vic*
 ⊖ 400 mm DIAMETER
 ⊖ 80 mm CENTRE DIAMETER



AR105 / AR105-V *Vic*
 ⊖ 650 mm DIAMETER
 ⊖ 60 mm CENTRE DIAMETER
 Available vented or un-vented



AR106 *Col*
 ⊖ 330 mm DIAMETER
 ⊖ 100 mm CENTRE DIAMETER



AR107 *Geo*
 ⊖ 480 mm DIAMETER
 ⊖ 30 mm CENTRE DIAMETER



AR108 / AR108-V *Vic*
 ⊖ 720 mm DIAMETER
 ⊖ 60 mm CENTRE DIAMETER
 Available vented or un-vented



AR109 *Col*
 ⊖ 710 mm DIAMETER
 ⊖ 90 mm CENTRE DIAMETER

ALL DIMENSIONS ARE APPROXIMATE

**AR110 / AR110-V** (Vic)

⊖ 530 mm DIAMETER

Available vented or un-vented

**AR111 / AR111-V** (Vic)

655 mm x 495 mm

□ 100 mm x 60 mm CENTRE

Available vented or un-vented

**AR112** (Art)

⊖ 770 mm DIAMETER

⊖ 100 mm CENTRE DIAMETER

**AR113** (Col)

⊖ 770 mm DIAMETER

⊖ 100 mm CENTRE DIAMETER

**AR114** (Art)

□ 1340 mm x 1070 mm

⊖ 90 mm CENTRE DIAMETER

**AR115** (Art)

□ 830 mm x 1240 mm

**AR116** (Art)

□ 910 mm x 525 mm

⊖ 75 mm CENTRE DIAMETER

**AR117** (Art)

⊖ 1250 mm x 950 mm

⊖ 110mm CENTRE DIAMETER

**AR118** (Vic)

⊖ 1100 mm DIAMETER

**AR119** (Vic)

⊖ 785 mm DIAMETER

⊖ 70mm CENTRE DIAMETER

**AR120** (Vic)

⊖ 785 mm DIAMETER

⊖ 70mm CENTRE DIAMETER

**AR121** (Vic)

⊖ 1100 mm DIAMETER

⊖ 70mm CENTRE DIAMETER



AR122 Vic
 ⊖ 1190 mm DIAMETER
 ⊖ 70mm CENTRE DIAMETER

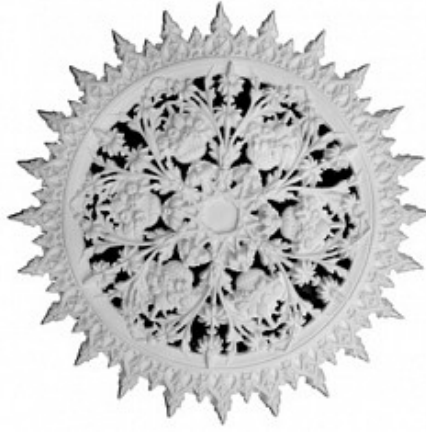

AR123 / AR123-V Vic
 ⊖ 1060 mm DIAMETER
 ⊖ 80 mm CENTRE DIAMETER
 Available vented or un-vented



AR124 / AR124-V Vic
 ⊖ 760 mm DIAMETER
 ⊖ 30 mm CENTRE DIAMETER
 Available vented or un-vented



AR125 Col Mod
 ⊖ 1010 mm DIAMETER
 ⊖ 130 mm CENTRE DIAMETER



AR126 / AR126-V Vic
 ⊖ 625 MM DIAMETER
 ⊖ 30mm Centre Diameter
 Available vented or un-vented



AR127 Vic
 ⊖ 420 mm DIAMETER
 30mm Centre Diameter



AR128 / AR128-V Vic
 ⊖ 300 mm DIAMETER
 30mm Centre Diameter
 Available vented or un-vented



AR129 Art
 □ 600 mm x 600 mm



AR130 Col
 ⊖ 480 mm DIAMETER
 ⊖ 125 mm CENTRE DIAMETER



AR131 Col
 ⊖ 625 mm DIAMETER
 ⊖ 125 mm CENTRE DIAMETER



AR132 Art
 □ 825 mm x 440 mm
 □ 80 x 80 mm CENTRE



AR133 Col
 ⊖ 725 mm DIAMETER
 ⊖ 40 mm CENTRE DIAMETER

ALL DIMENSIONS ARE APPROXIMATE



AR134 (Geo)
 ⊖ 570 mm DIAMETER
 ⊖ 110 mm CENTRE DIAMETER



AR135 (Col)
 ⊖ 660 mm DIAMETER
 ⊖ 70 mm CENTRE DIAMETER



AR136 (Col)
 ⊖ 660 mm DIAMETER
 ⊖ 70 mm CENTRE DIAMETER



AR137 (Fed)
 ⊖ 750 mm DIAMETER
 ⊖ 160 mm CENTRE DIAMETER



AR138 (Col)
 ⊖ 190 mm DIAMETER
 ⊖ 50 mm CENTRE DIAMETER



AR139 (Art)
 ⊖ 590 mm DIAMETER
 ⊖ 85 mm DEPTH



AR140 (Col)
 □ 360 mm x 890 mm
 □ 40 mm x 110 mm CENTRE



AR141 (Vic)
 □ 1020 mm x 850 mm
 ⊖ 90 mm CENTRE DIAMETER



AR142 / AR142-V (Vic)
 ⊖ 540 mm DIAMETER
 ⊖ 90 mm CENTRE DIAMETER
 Available vented or un-vented



AR143 / AR143-V (Vic)
 ⊖ 580 mm DIAMETER
 ⊖ 75 mm CENTRE DIAMETER
 Available vented or un-vented



AR144 / AR144-V (Vic)
 ⊖ 750 mm DIAMETER
 ⊖ 100 mm CENTRE DIAMETER
 Available vented or un-vented



AR145 / AR145-V (Vic)
 ⊖ 1080 mm DIAMETER
 ⊖ 100 mm CENTRE DIAMETER
 Available vented or un-vented

**AR146** Col

510 mm x 355 mm
250 mm x 100 mm CENTRE

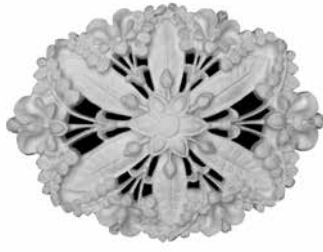
**AR147 / AR147-V** Vic

460 mm x 330 mm
30 mm CENTRE DIAMETER

Available vented or un-vented

**AR148** Vic

480 mm DIAMETER
30 mm CENTRE DIAMETER

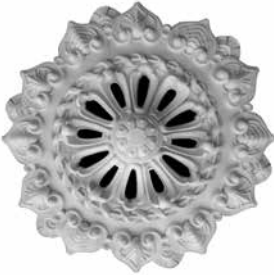
**AR149 / AR149-V** Vic

480 mm DIAMETER
80 mm CENTRE DIAMETER

Available vented or un-vented

**AR150 / AR150-V** Vic

750 mm DIAMETER
100 mm CENTRE DIAMETER

Available vented or un-vented

**AR151** Vic

350 mm DIAMETER
30 mm CENTRE DIAMETER

**AR152** Geo

1000 mm DIAMETER

**AR153** Geo

890 mm DIAMETER

**AR154** Col

340 mm DIAMETER
20 mm CENTRE DIAMETER

**AR155** Fed

600 mm DIAMETER
75 mm CENTRE DIAMETER

**AR156** Fed

595 mm DIAMETER
20 mm CENTRE DIAMETER

**AR157** Vic

460 mm DIAMETER
55 mm CENTRE DIAMETER

ALL DIMENSIONS ARE APPROXIMATE





AR158 / AR158-V Geo
 ⊖ 580 mm DIAMETER
 Available vented or un-vented



AR159 Vic
 □ 400 mm x 400 mm
 ⊖ 30 mm CENTRE



AR160 / AR160-V Vic
 □ 940 mm x 590 mm
 Available vented or un-vented

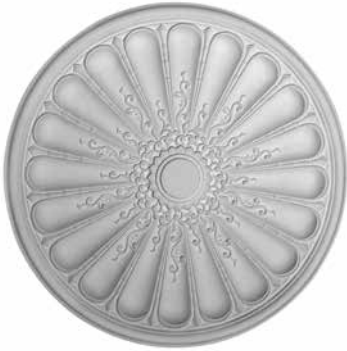

AR161 Col
 ⊖ 800 mm DIAMETER
 ⊖ 85 mm CENTRE DIAMETER



AR162 Fed
 ⊖ 530 mm DIAMETER
 ⊖ 25 mm CENTRE DIAMETER



AR163 Fed
 ⊖ 600 mm DIAMETER
 ⊖ 85 mm CENTRE DIAMETER



AR164 Col
 ⊖ 750 mm DIAMETER
 ⊖ 80 mm CENTRE DIAMETER



AR165 Col
 ⊖ 830 mm DIAMETER
 ⊖ 60 mm CENTRE DIAMETER



AR166 Col
 ⊖ 675 mm DIAMETER
 ⊖ 85 mm CENTRE DIAMETER



AR167 Vic
 ⊖ 510 mm DIAMETER
 ⊖ 65 mm CENTRE DIAMETER



AR168 Vic
 ⊖ 200 mm DIAMETER
 ⊖ 20 mm CENTRE DIAMETER



AR169 Vic
 ⊖ 300 mm DIAMETER
 ⊖ 55 mm CENTRE DIAMETER



AR170 Vic
 ⊖ 600 mm DIAMETER
 ⊖ 80 mm CENTRE DIAMETER



AR171 Geo
 ⊖ 800 mm DIAMETER
 ⊖ 80 mm CENTRE DIAMETER



AR172 Vic
 ⊖ 1000 mm DIAMETER
 ⊖ 130 mm CENTRE DIAMETER

Medallions



AMD1 Vic
 ⊖ 150 mm DIAMETER
 ↓ 20 mm DEPTH



AMD2 Vic
 ⊖ 230 mm DIAMETER
 ↓ 30 mm DEPTH



AMD3 Vic
 ⊖ 195 mm DIAMETER

Embellishments

Can be made in plaster or lightweight resin (POA).



AEM1 Fed
 □ 440 mm x 170 mm
 ↓ 45 mm DEPTH



AEM2 Fed
 □ 470 mm x 110 mm
 ↓ 30 mm DEPTH



AEM3 Vic
 □ 420 mm x 225 mm
 ↓ 45 mm DEPTH



AEM5 Fed
 □ 380 mm x 130 mm
 ↓ 50 mm DEPTH



AEM4 Fed
 □ 420 mm x 225 mm
 ↓ 45 mm DEPTH

ALL DIMENSIONS ARE APPROXIMATE



Ceiling Domes

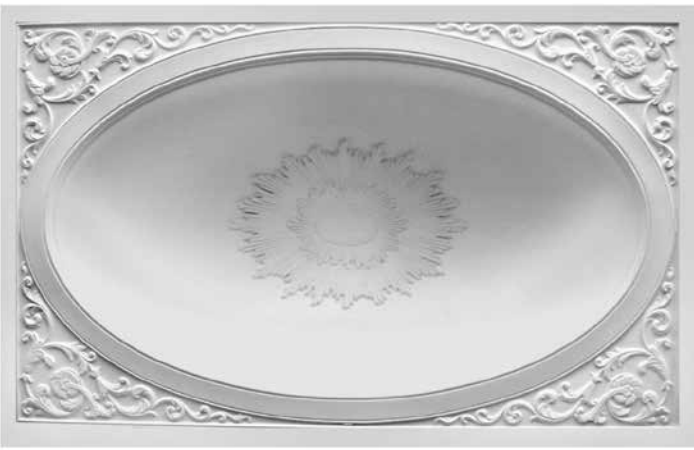

Pictured
Custom dome
AS39 Curved Strip & A81 Cornice

**AD1** Vic

□ 1940 mm X 1250 mm

↓ 460 mm DEPTH

— 90 mm EDGE

Also available without decorative centre. POA

**AD2** Col

⊖ 660 mm DIAMETER

↓ 100 mm DEPTH

**AD1C** Vic

□ 1680 mm x 960 mm

↓ 460 mm DEPTH

— 90 mm EDGE

Also available without decorative centre. POA

**AD3** Col

⊖ 1010 mm DIAMETER

↓ 130 mm DEPTH

**AD4** Col

⊖ 900 mm DIAMETER

↓ 130 mm DEPTH

ADP4 Col

DOME LIGHT PELMET PROFILE

⊖ 760 mm INSIDE DIAMETER

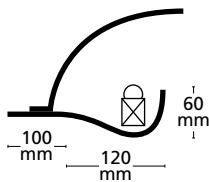
**AD5** Vic

⊖ 1050 mm DIAMETER

↓ 250 mm DEPTH



Ceiling Domes can be manufactured to suit any design, shape or size. We have light pelmets on selected domes where LED strip lighting can be used to enhance the look of the dome. Custom light pelmets can be made to suit any size or design. Please ask for more details.

ALL DIMENSIONS ARE APPROXIMATE

**AD6** *Col*

- 2375 mm x 1760 mm
- ↓ 240 mm DEPTH
- ≡ 90 mm EDGE

**AD7** *Col*

- ⊖ 1550 mm DIAMETER
- ↓ 300 mm DEPTH

**AD6C** *Col*

- 1975 mm x 1380 mm
- ↓ 240 mm DEPTH
- ≡ 90 mm EDGE

**AD8** *Col*

- ⊖ 2000 mm DIAMETER
- ↓ 300 mm DEPTH

ADP8 *Col*

- DOME LIGHT PELMET PROFILE
- ⊖ 1600 mmC

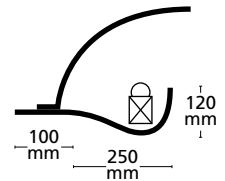
**AD9** *Col*

- ⊖ 4000 mm DIAMETER
- ↓ 400 mm DEPTH

ADP9 *Col*

- DOME LIGHT PELMET PROFILE
- ⊖ 3500 mm INSIDE DIAMETER

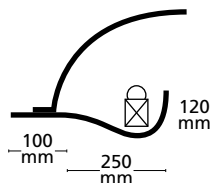
**AD10** *Col*

- ⊖ 1440 mm DIAMETER
- ↓ 405 mm DEPTH

ADP10 *Mod*

- DOME LIGHT PELMET PROFILE
- ⊖ 1250 mm DIAMETER

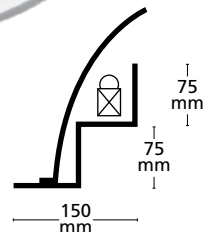



AD11 *Col*
⊖ 3690 mm DIAMETER
↓ 400 mm DEPTH

ADP11 *Col*
DOME LIGHT PELMET PROFILE
⊖ 3570 mm DIAMETER

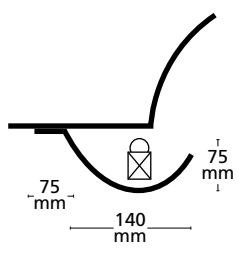

AD12 *Col*
⊖ 390 mm DIAMETER
⊖ 180 mm CENTRE DIAMETER
↓ 30 mm DEPTH



AD13 *Vic*
⊖ 760 mm DIAMETER
↓ 110 mm DEPTH



Pictured
Custom Ceiling Dome
A227 Cornice used for Pelmet

ALL DIMENSIONS ARE APPROXIMATE

Ceiling Panels



Pictured
AP2A & AP2B Ceiling Panels
AB21 Boss used to join panels
AR44 Ceiling Centres



AP1(a) Lyrebird Fed

□ 920 mm x 920 mm
 ↓ 13 mm



AP1(b) Lyrebird Fed

□ 920 mm x 920 mm
 ↓ 13 mm



AP2(a) Waratah Fed

□ 920 mm x 920 mm
 ↓ 13 mm



AP2(b) Waratah Fed

□ 920 mm x 920 mm
 ↓ 13 mm



AP3 Lyrebird Fed

□ 920 mm x 920 mm
 ↓ 13 mm





AP4 Fed

□ 930 mm x 930 mm
 ↓ 13 mm

**AP5(a)** Fine Rose 

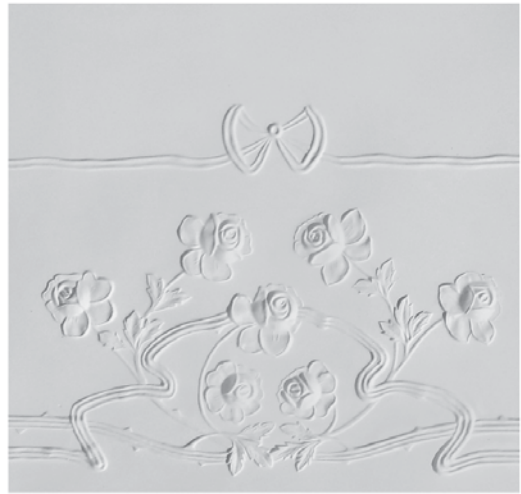

□ 930 mm x 930 mm

┆ 13 mm

**AP5(b)** Fine Rose 

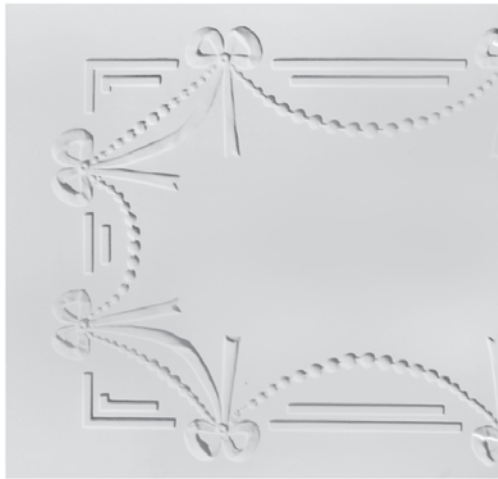

□ 930 mm x 930 mm

┆ 13 mm

**AP6(a)** Hallway Panel 

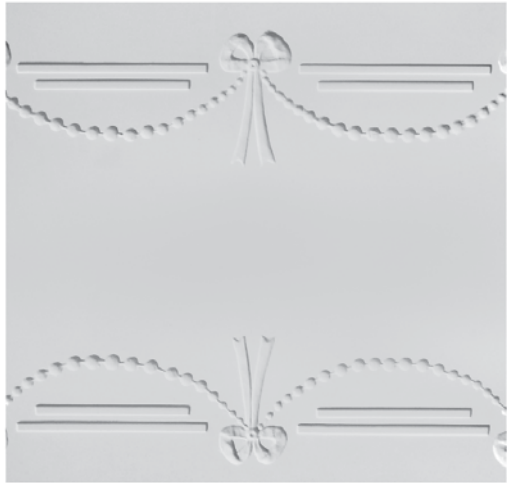

□ 1070 mm x 920 mm

┆ 13 mm

**AP6(b)** Hallway Panel 

□ 1070 mm x 920 mm

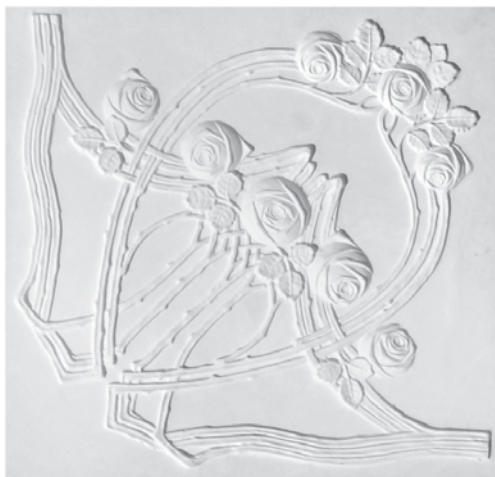
┆ 13 mm

**AP7(a)** Bold Rose 

□ 930 mm x 930 mm

┆ 13 mm

**AP7(b)** Bold Rose 

□ 930 mm x 930 mm

┆ 13 mm



AP8 Large Adams 
 □ 2755 mm x 1400 mm
 ↓ 13 mm



AP9 
 □ 900 mm x 900 mm
 ↓ 13 mm



AP10 
 □ 2100 mm x 1350 mm
 ↓ 13 mm

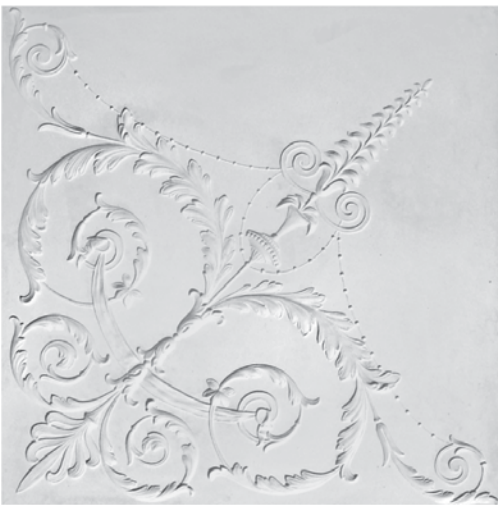

AP11(a) 
 □ 1000 mm x 1000 mm
 ↓ 13 mm



AP11(b) 
 □ 1000 mm x 1000 mm
 ↓ 13 mm

ALL DIMENSIONS ARE APPROXIMATE

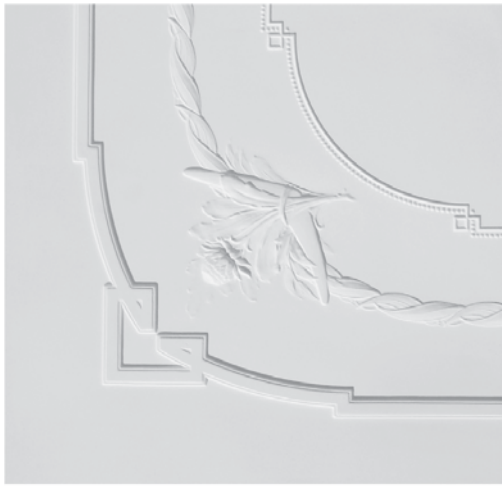

AP12(a) Fine Warratah 

□ 930 mm x 930 mm
 ↓ 13 mm



AP12(b) Fine Warratah 

□ 930 mm x 930 mm
 ↓ 13 mm



AP13(a) 

□ 940 mm x 940 mm
 ↓ 13 mm



AP13(b) 

□ 940 mm x 940 mm
 ↓ 13 mm



AP14 

□ 1380 mm x 1380 mm
 ↓ 13 mm



AP15 

□ 930 mm x 930 mm
 ↓ 13 mm

**AP17(a) (Hallway Panel)** Fed

□ 1400 mm x 1080 mm
 ↓ 13 mm

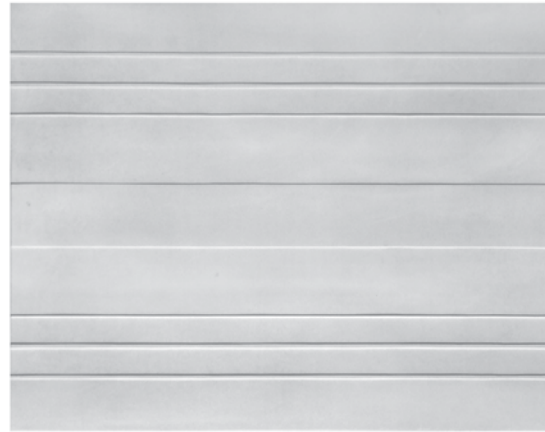
**AP17(b) (Infill)** Fed

□ 1400 mm x 1080 mm
 ↓ 13 mm

**AP16** Fed

□ 935 mm x 935 mm
 ↓ 13 mm

**AP19** Fed

□ 935 mm x 935 mm
 ↓ 13 mm

**AP18(a)** Fed

□ 940 mm x 940 mm
 ↓ 13 mm

**AP18(b)** Fed

□ 940 mm x 940 mm
 ↓ 13 mm

**AP20(a)** Fed

□ 930 mm x 930 mm
 ↓ 13 mm

**AP20(b)** Fed

□ 930 mm x 930 mm
 ↓ 13 mm

**AP21(a)** Fed

□ 935 mm x 935 mm
 ↓ 13 mm

**AP21(b)** Fed

□ 935 mm x 935 mm
 ↓ 13 mm

**AP22(a)** Fed

□ 940 mm x 940 mm
 ↓ 13 mm

**AP22(b)** Fed

□ 940 mm x 940 mm
 ↓ 13 mm

**AP23(a)** Fed

□ 945 mm x 945 mm
 ↓ 13 mm

**AP23(b)** Fed

□ 945 mm x 945 mm
 ↓ 13 mm

**AP24(a)** Fed

□ 930 mm x 930 mm
 ↓ 13 mm

**AP24(b)** Fed

□ 930 mm x 930 mm
 ↓ 13 mm

**AP25(a)** Fed

□ 925 mm x 925 mm
 ↓ 13 mm

**AP25(b)** Fed

□ 925 mm x 925 mm
 ↓ 13 mm

**AP26(a)** Fed

□ 1240 mm x 1240 mm
 ↓ 13 mm

**AP26(b)** Fed

□ 1240 mm x 1240 mm
 ↓ 13 mm

**AP27** Fed

□ 1230 mm x 1230 mm
 ↓ 13 mm

**AP28 (Wall Panel)** Col

□ 1210 mm x 810 mm
 ↓ 13 mm

AS43 Recessed chair rail strip available for on top of pannel as capping

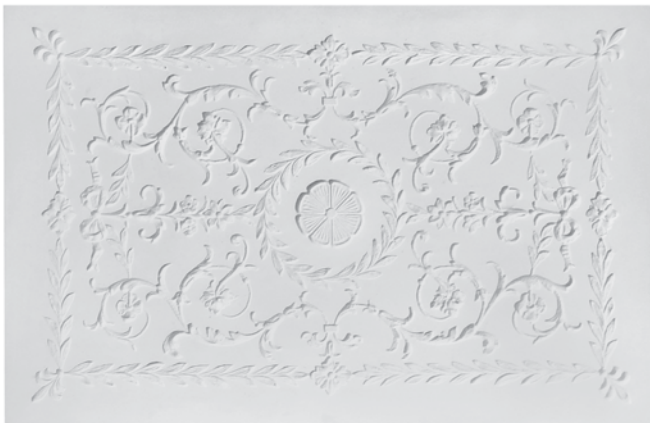
**AP29 (Hallway Panel)** Fed

□ 1400 mm x 930 mm
 ↓ 13 mm

**AP30** Fed

□ 1240 mm x 1240 mm
 ↓ 13 mm



AP31 Vic

□ 940 mm x 940 mm
┆ 13 mm



AP32 Fed

□ 1070 mm x 1070 mm
┆ 13 mm



AP33 Fed

□ 930 mm x 930 mm
┆ 13 mm



AP34 Fed

□ 1170 mm x 1170 mm
┆ 13 mm



AP35 Fed

□ 1200 mm x 1200 mm
┆ 13 mm



AP36 Fed

□ 960 mm x 960 mm
┆ 13 mm

**AP37** Fed

□ 950 mm x 950 mm
 ↓ 13 mm

**AP38 (Plain Fibrous Panel)**

□ 3000 mm x 1200 mm
 ↓ 13 mm

Used to infill around ceiling pannels or for heritage restoration

**AP39(a)** Fed

□ 930 mm x 930 mm
 ↓ 13 mm

**AP39(b)** Fed

□ 930 mm x 930 mm
 ↓ 13 mm

**AP40 (Continuous Pattern)** Col

□ 1720 mm x 1150 mm
 ↓ 13 mm

**AP41 (Continuous Pattern)** Col

□ 1200 mm x 1200 mm
 ↓ 13 mm



AP42 Fed
 □ 2435 mm x 1470 mm
 ↓ 13 mm



AP43 Fed
 □ 920 mm x 920 mm
 ↓ 13 mm



AP44 Fed
 □ 920 mm x 920 mm
 ↓ 13 mm



AP45 Fed
 □ 920 mm x 920 mm
 ↓ 13 mm



AP46 Fed
 □ 940 mm x 940 mm
 ↓ 13 mm

ALL DIMENSIONS ARE APPROXIMATE

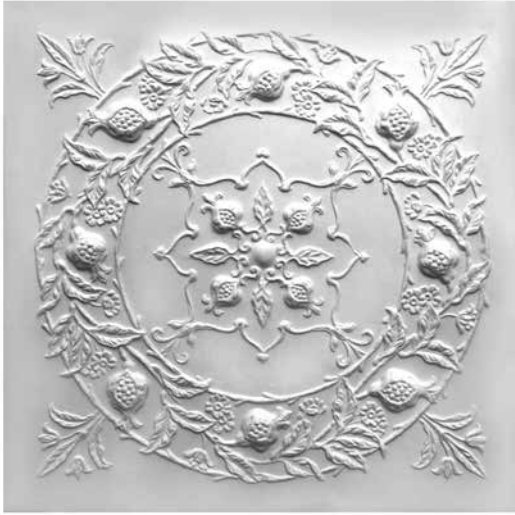
**AP47** Fed

□ 920 mm x 920 mm
 ↓ 13 mm

**AP48** Fed

□ 975 mm x 975 mm
 ↓ 13 mm

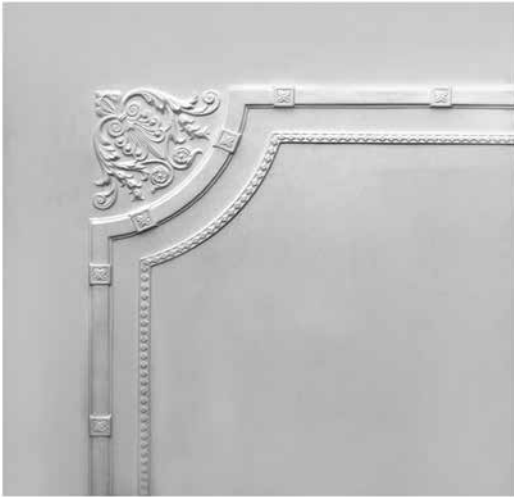
**AP49** Col

□ 1395 mm x 1395 mm
 ↓ 13 mm

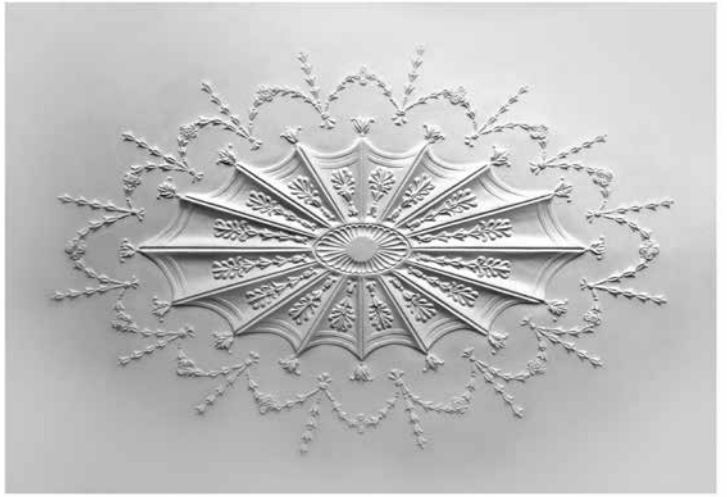
**AP50** Fed

□ 2050 mm x 1410 mm
 ↓ 13 mm

**AP51(a)** Fed

□ 1385 mm x 1385 mm
 ↓ 13 mm

**AP51(b)** Fed

□ 1385 mm x 1385 mm
 ↓ 13 mm

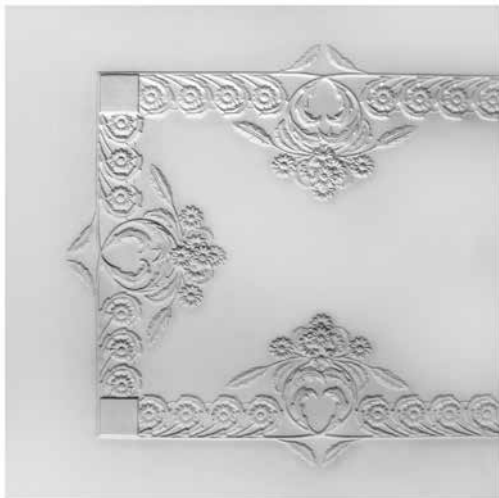

AP52(a) (Hallway Panel End) (Fed)

□ 1070 mm x 1070 mm

↓ 13 mm

HALLWAY PANEL

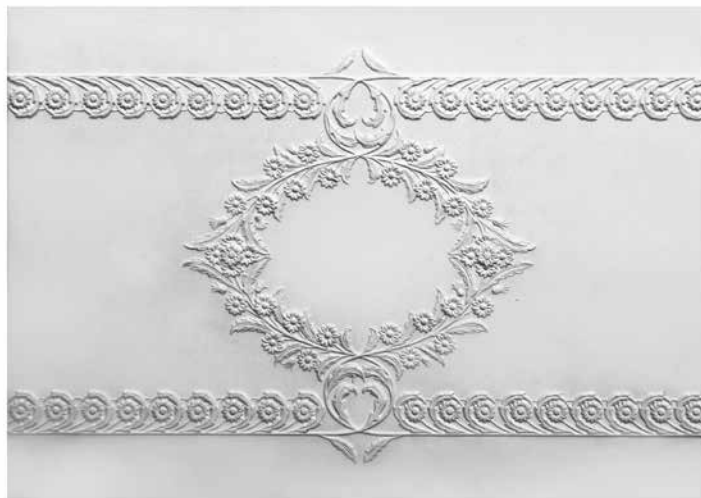

AP52(b) (Hallway Panel Infill) (Fed)

□ 1070 mm x 1535 mm

↓ 13 mm

HALLWAY PANEL

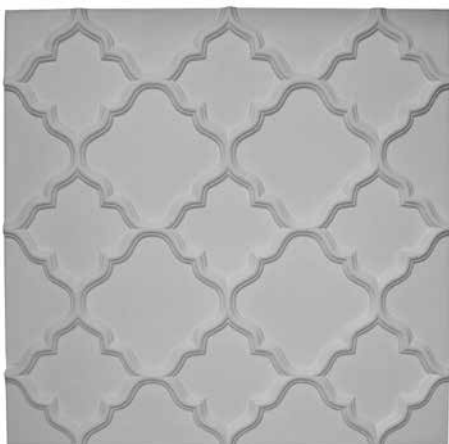

AP53 (Continuous Pattern) (Vic)

□ 1070 mm x 1070 mm

↓ 13 mm

HALLWAY PANEL

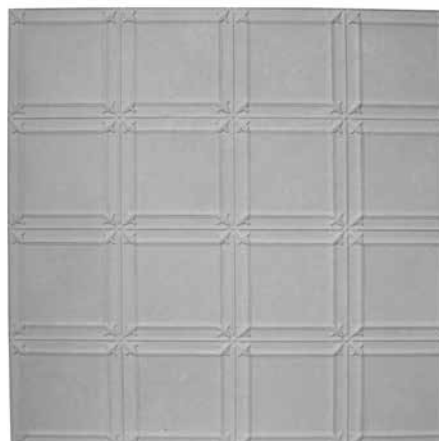

AP54 (Continuous Pattern) (Col)

□ 1070 mm x 1535 mm

↓ 13 mm

HALLWAY PANEL



AP55 (Col)

□ 515 mm x 515 mm

↓ 10 mm

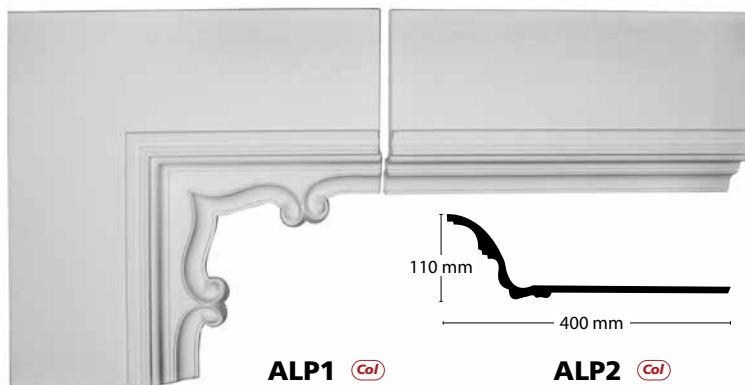

Light Pelmet

ALP1 (Col)

□ 800 mm x 800 mm

↓ 120 mm

ALP2 (Col)

□ 2000 mm x 310 mm

↓ 120 mm



These can be used in conjunction with ceiling panels AP53 or AP54, or with a continuous ceiling panel to make a light pelmet ceiling to almost any sized room. POA

Strips



Pictured
AS42 Strip
AR32 Ceiling Centre

AS1 *Fed*

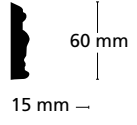

AS10 *Col*

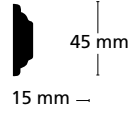

AS2 *Fed*

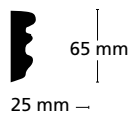

AS11 *Vic*

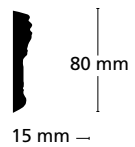

AS3 *Col*

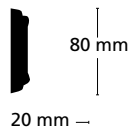

AS12 *Geo*



AS4 *Col*

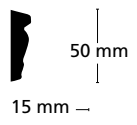

AS13 *Col*

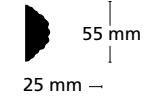

AS5 *Fed*

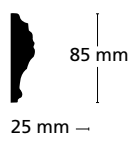

AS14 *Vic*



AS6 *Vic*

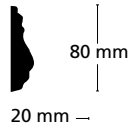

AS15 *Vic*



AS7 *Col*

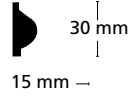

AS16 *Vic*



AS8 *Col*

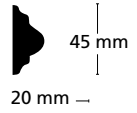

AS17 *Art*

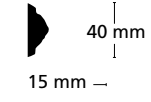

AS9 *Vic*

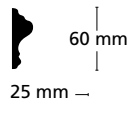

Strips can be used on the wall as a chair rail, picture frames on walls or boxes. When used on the ceiling they can border a cornice following the shape of your room or be used in conjunction with bosses to frame or border ceiling panels, or with strip corners to make a feature ceiling.

ALL DIMENSIONS ARE APPROXIMATE

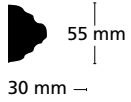
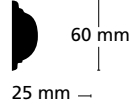
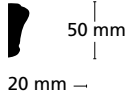
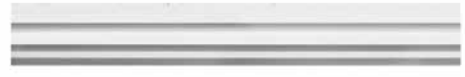
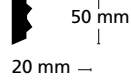
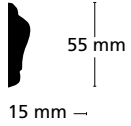
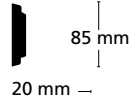
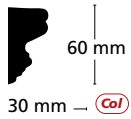
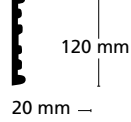
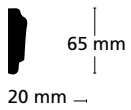
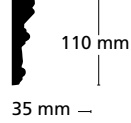
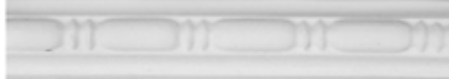
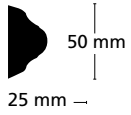
AS18 *Art***AS27** *Vic***AS19** *Col***AS28** *Col***AS20** *Col***AS29** *Mod***AS21****AS30** *Art***AS22** *Vic***AS31** *Vic***AS23** *Col*

3.0m Lengths

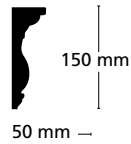
AS32 *Vic*

3.0m Lengths

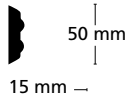
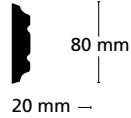
AS24 *Col***AS33** *Art*

3.0m Lengths

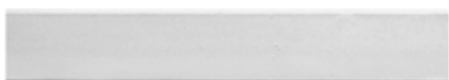
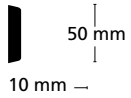
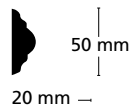
AS25 *Mod***AS34** *Vic*

Matches AR51 Ceiling Rings

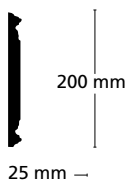
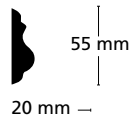
AS26 *Art***AS35** *Vic*

AS36 (Vic)



AS37 (Vic)



AS38 (Geo)



AS39 (Geo)



AS40 (Art)



AS41 (Geo)



AS42 (Vic)



AS43 (Vic)



*Recessed chair rail strip for AP28 Wall Panel

AS44 (Col)

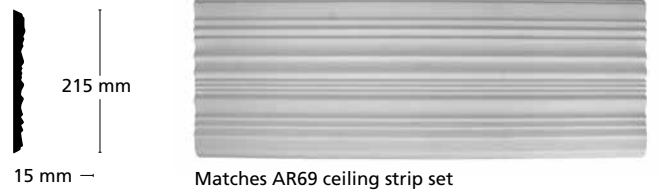

AS45 (Col)



AS46 (Vic)



AS47 (Vic)



AS48 (Vic)



AS49 (Col)



AS50 (Vic)



AS51 (Fed)



AS52 (Col)**AS62** (Vic)**AS53** (Col)**AS63** (Col)**AS54** (Art)**AS64** (Col)**AS55** (Vic)**AS65** (Col)**AS56** (Vic)**AS66** (Col)**AS57** (Col)**AS67** (Col)**AS58** (Mod)**AS68** (Mod)**AS59** (Mod)**AS69** (Col)**AS60** (Col)**AS61** (Col)**AS70** (Mod)**AS71** (Art)

Strip Corners



AK1 Fed
 □ 340 mm x 320 mm
 Matches AS1 Strip



AK2 Fed
 □ 280 mm x 310 mm
 Matches AS2 Strip



AK3 Vic
 □ 320 mm x 320 mm



AK4 (a) Col
 □ 280 mm x 280 mm
 Matches AS4 Strip



AK4 (b) Col
 □ 220 mm x 220 mm
 Matches AS4 Strip



AK5 Fed
 □ 395 mm x 395 mm
 Matches AS5 Strip



AK6 (a) Fed
 □ 370 mm x 370 mm
 Matches AS6 Strip



AK6 (b) Fed
 □ 415 mm x 415 mm
 Matches AS6 Strip



AK8 Col
 □ 215 mm x 215 mm
 Matches AS8 Strip



AK9 (a) Vic
 □ 280 mm x 280 mm
 Matches AS9 Strip



AK9 (b) Vic
 □ 300 mm x 300 mm
 Matches AS9 Strip



AK9 (c) Vic
 □ 240 mm x 240 mm
 Matches AS9 Strip



AK10 (a) Col
 □ 245 mm x 245 mm
 Matches AS10 Strip



AK10 (b) Col
 □ 330 mm x 330 mm
 Matches AS10 Strip



AK14 Vic
 □ 310 mm x 310 mm
 Matches AS14 Strip



AK18 Art
 □ 290 mm x 290 mm
 Matches AS18 Strip

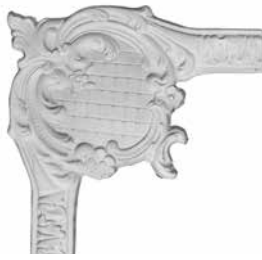

AK22 (a) Vic
 330 mm x 330 mm
 Matches AS22 Strip



AK22 (b) Vic
 330 mm x 330 mm
 Matches AS22 Strip



AK47 Vic
 205 mm x 205 mm
 Matches AS47 Strip



AK48 (a) Vic
 230 mm x 230 mm
 Matches AS48 Strip



AK48 (b) Vic
 200 mm x 200 mm
 Matches AS48 Strip



AK50 Vic
 280 mm x 280 mm
 Matches AS50 Strip



AK55 Vic
 230 mm x 230 mm
 Matches AS55 Strip



AK60 Col
 250 mm x 250 mm
 Matches AS60 Strip



AK62 (a) Vic
 210 mm x 210 mm
 Matches AS62 Strip



AK62 (b) Vic
 215 mm x 215 mm
 Matches AS62 Strip



Virtual Showroom

Perfect for matching your choice of ceiling centre or dome with the perfect cornice visit us at www.allplasta.com.au

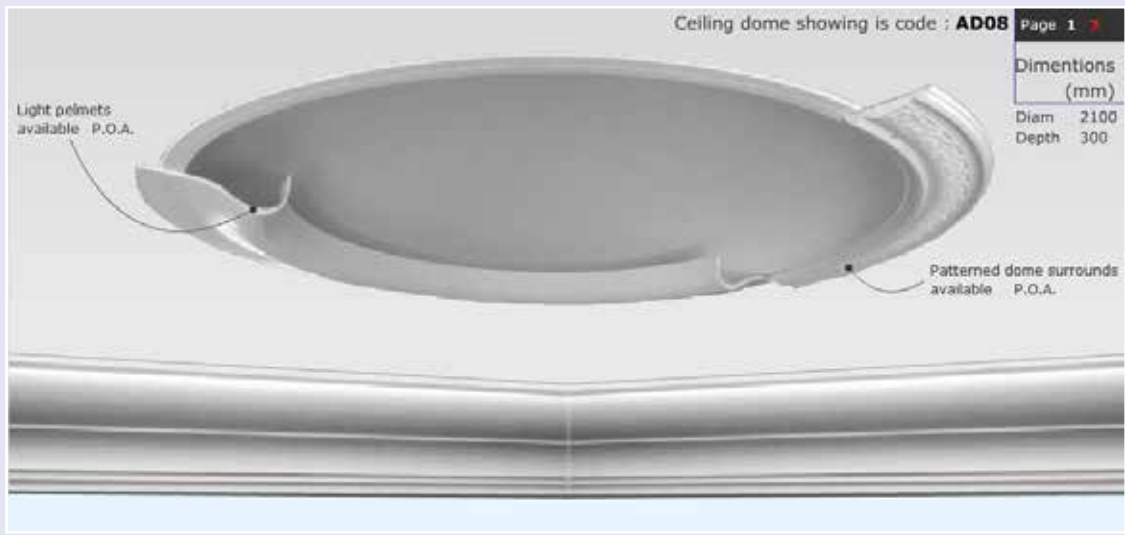

Visit us instore or order online at www.allplasta.com.au

Bosses



AB1 *Fed*
□ 115mm x 115 mm
↓ 60 mm DEPTH
Suits AS34, AS36 Strips



AB2 *Fed*
□ 100 mm x 100 mm
↓ 40 mm DEPTH
Suits AS34, AS36 Strips



AB3 *Fed*
□ 110 mm x 110 mm
↓ 50 mm DEPTH
Suits AS34, AS36 Strips



AB4 *Art*
□ 70 mm x 70 mm
↓ 45 mm DEPTH



AB5 *Fed*
□ 75 mm x 75 mm
↓ 30 mm DEPTH



AB6 *Fed*
□ 95 mm x 95 mm
↓ 60 mm DEPTH



AB7 *Fed*
□ 110 mm x 110 mm
↓ 70 mm DEPTH



AB8 *Fed*
□ 90 mm x 90 mm
↓ 25 mm DEPTH



AB9 *Fed*
□ 120 mm x 120 mm
↓ 55 mm DEPTH



AB10 *Fed*
□ 75 mm x 75 mm
↓ 35 mm DEPTH
Suits AS24 Strip



AB11 *Fed*
⊖ 180 mm DIAMETER
↓ 10 mm DEPTH



AB12 *Fed*
□ 75 mm x 75 mm
↓ 30 mm DEPTH

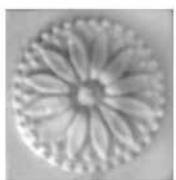

AB13 *Fed*
□ 75 mm x 75 mm
↓ 20 mm DEPTH



AB14 *Fed*
□ 80 mm x 80 mm
↓ 45 mm DEPTH
Suits AS24 Strip



AB15 *Fed*
□ 140 mm x 100 mm
↓ 15 mm DEPTH



AB16 *Fed*
□ 300 mm x 300 mm
↓ 30 mm DEPTH



AB17 *Col*
□ 90 mm x 90 mm
↓ 25 mm DEPTH



AB18 *Vic*
□ 65 mm x 65 mm
↓ 25 mm DEPTH



AB19 *Fed*
□ 135 mm x 135 mm
↓ 25 mm DEPTH



AB20 *Col*
□ 60 mm x 60 mm
↓ 30 mm DEPTH



AB21 *Fed*
Ceiling Panel Strip
Joiner for AP2a and AP2b
□ 60 mm x 60 mm
↓ 25 mm DEPTH



AB22 *Col*
□ 200 mm x 200 mm
↓ 30 mm DEPTH



AB23 *Mod*
□ 135 mm x 135 mm
↓ 25 mm DEPTH



AB24 *Vic*
□ 110 mm x 110 mm
↓ 20 mm DEPTH

ALL DIMENSIONS ARE APPROXIMATE

Coffered Ceiling Panels



Pictured
Burj Tower Dubai, made and installed by Allplasta
A304 Cornice
PC5 Pilaster Capitals
ACC3A and ACC3B Coffered Ceiling Panels



ACC1 Joining Panel Geo

- 1860 mm x 630 mm
- ↳ 30 mm Protrude at back
Into ceiling



ACC2 End Panel Geo

- 1860 mm x 695 mm
- ↳ 30 mm Protrude at back
Into ceiling



ACC3A Geo

- 2950 mm x 1335 mm
- ↳ 55 mm Protrude at back
Into ceiling

One of a set of four panels.
See picture below



ACC3B Geo

- 2950 mm x 1335 mm
- ↳ 55 mm Protrude at back
Into ceiling

One of a set of four panels.
See picture below

ACC3A-x2 ACC3B-x2

- 5900 mm x 2670 mm
- ↳ 55 mm Protrude at back
Into ceiling

| | |
|-------|-------|
| ACC3A | ACC3B |
| ACC3B | ACC3A |

A set of four panels includes
2 x ACC3A and 2 x ACC3B

2670mm

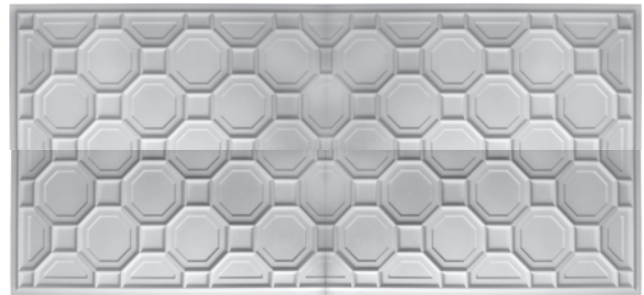

5960mm



ACC4 Geo

- 600 mm x 600 mm
- ↳ 80 mm Protrude at back
Into ceiling



ACC5 Col

- 600 mm x 600 mm
- ↳ 140 mm Protrude at back
Into ceiling

ALL DIMENSIONS ARE APPROXIMATE

Arches

Arches



Pictured
ACA2 Classic Arch
AFP13 Pilasters

ALLPLASTA



Adjustable Robe Arch

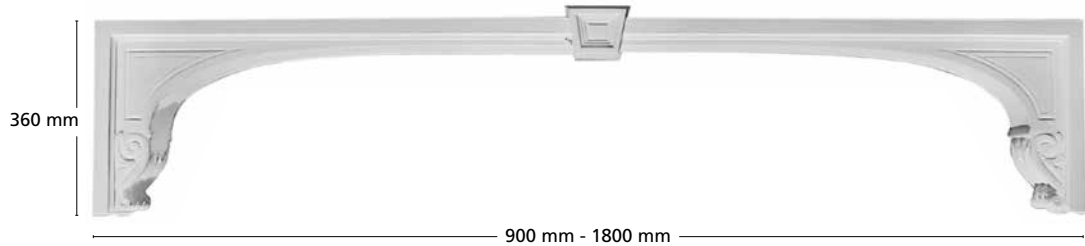
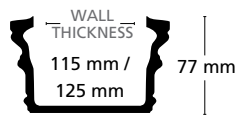

RA1 (Col) 115 mm WALL THICKNESS

RA2 (Col) 125 mm WALL THICKNESS

K8 (Col) (Key Stone optional extra) Adjustable length. To suit 3" and 4" studs. Extensions available in 1200 mm sections.

RE1 (Col) (Extension Piece)

Arch Set Includes:

- 2 x Arch Sections
- Optional Extras
- 1 x K7 Keystone Set (optional POA)

Adjustable Corner Archway

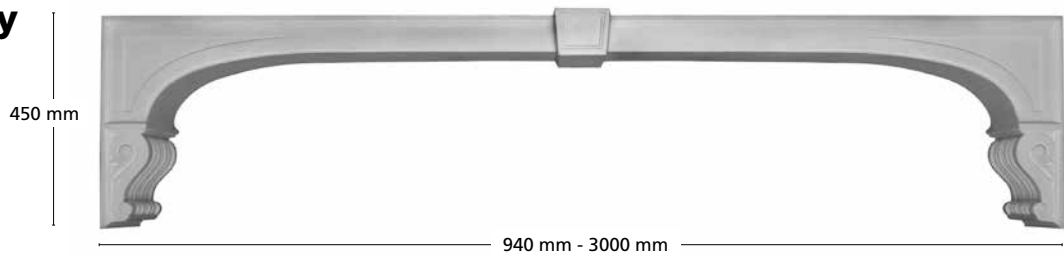
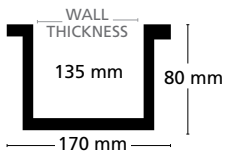

CA2 (Col) 135 mm WALL THICKNESS

Arch Set Includes:

- 2 x Arch Sections
- Optional Extras
- 1 x K7 Keystone Set (optional POA)

Arabic Arch

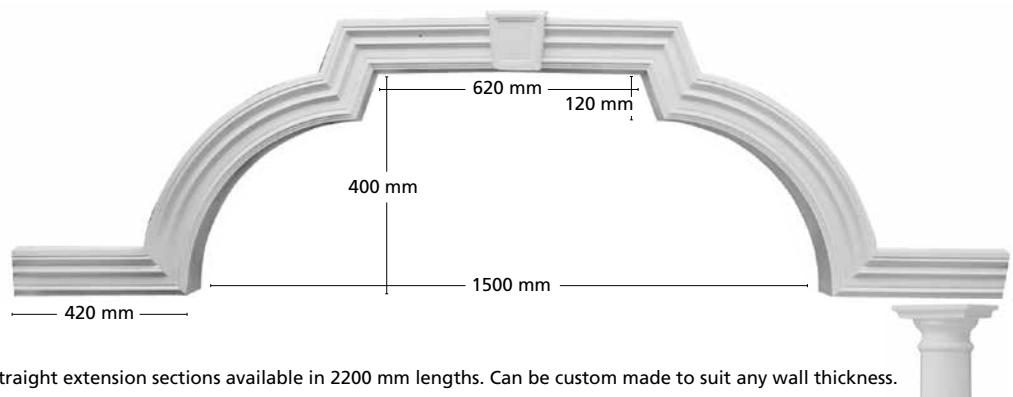

AB1 (Col) 250 mm WALL THICKNESS

ABE1 (Col) (Extension Piece)

Straight extension sections available in 2200 mm lengths. Can be custom made to suit any wall thickness.

Columns usually placed under ends

Arch Set Includes:

- 2 x Arch Sections
- Optional Extras
- 1 x K9 Keystone Set (optional POA)

Semi Elliptical Arch

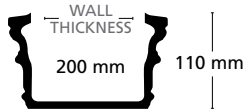

ASE1  200 mm WALL THICKNESS

Arch Set Includes:

- 2 x Arch Sections
- 1 x Corbels Set
- Optional extras
- 1 x K9 Keystone Set (optional POA)

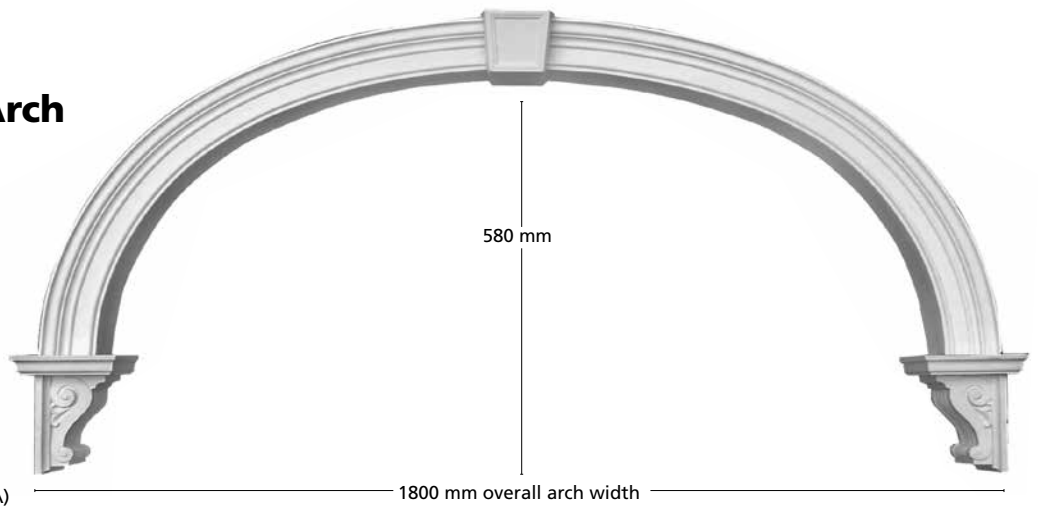

Can be custom made to suit wider openings POA.

Semi Circular Arch

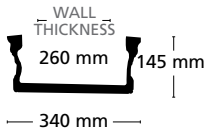

ASE2  260 mm WALL THICKNESS

Arch Set Includes:

- 1 x Arch Section
- 2 x Plinths AAP3
- 2 x Corbels

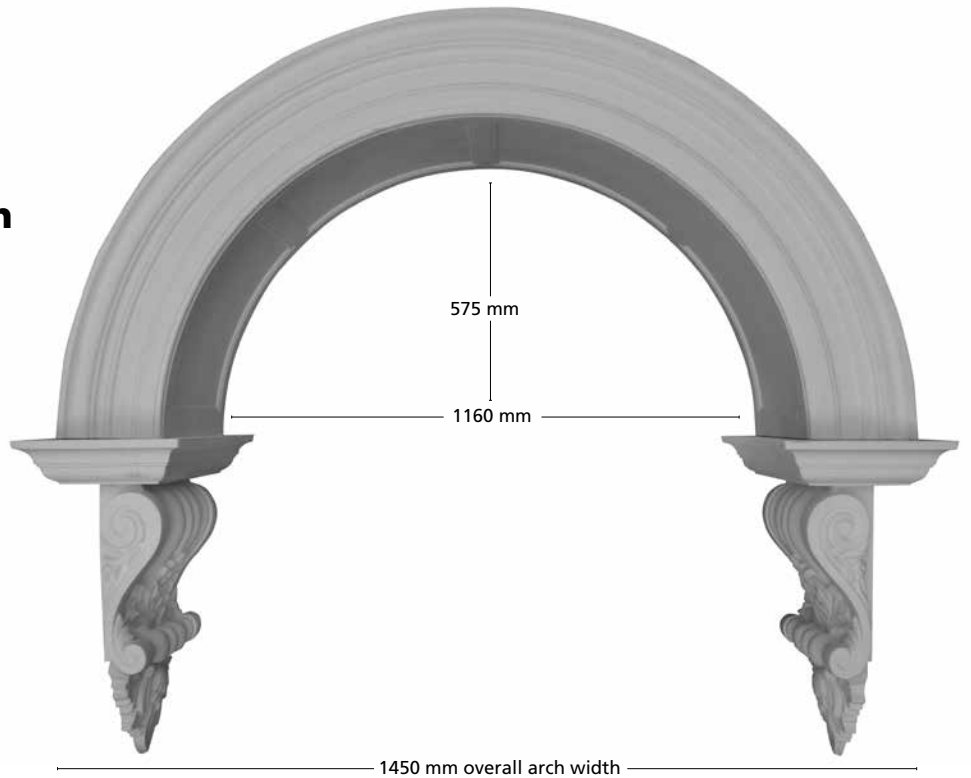

Can be custom made to suit any wall thickness POA

Semi Circular Arch



ASE3  260 mm WALL THICKNESS

Arch Set Includes:

- 1 x Arch Section
- 2 x Plinths AAP3
- 2 x Corbels

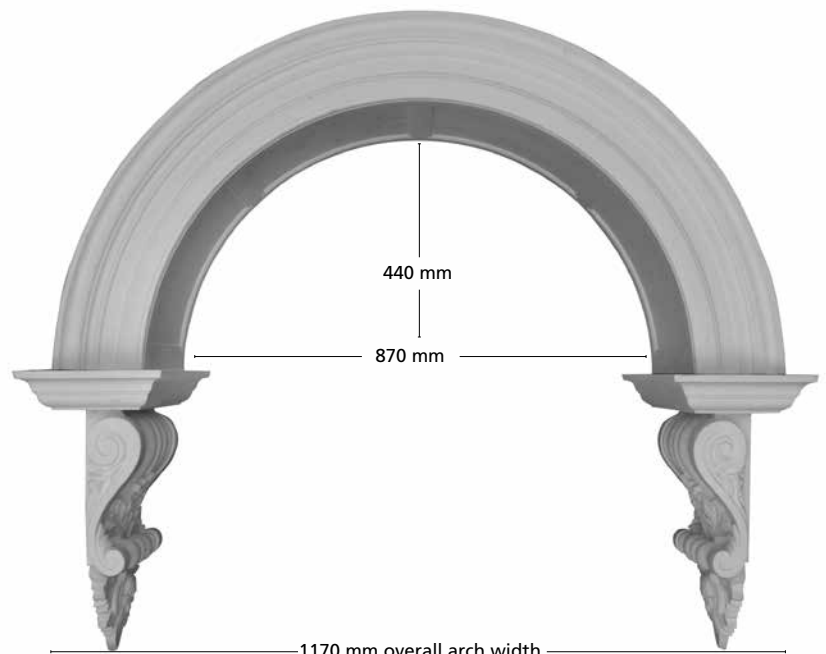

Can be custom made to suit any wall thickness POA

Visit us instore or order online at www.allplasta.com.au

Semi Circular Arch

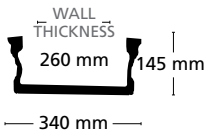

ASE4 (Vic) 260 mm WALL THICKNESS

Arch Set Includes:

- 1 x Arch Section
- 2 x Plinths AAP3
- 2 x Corbels

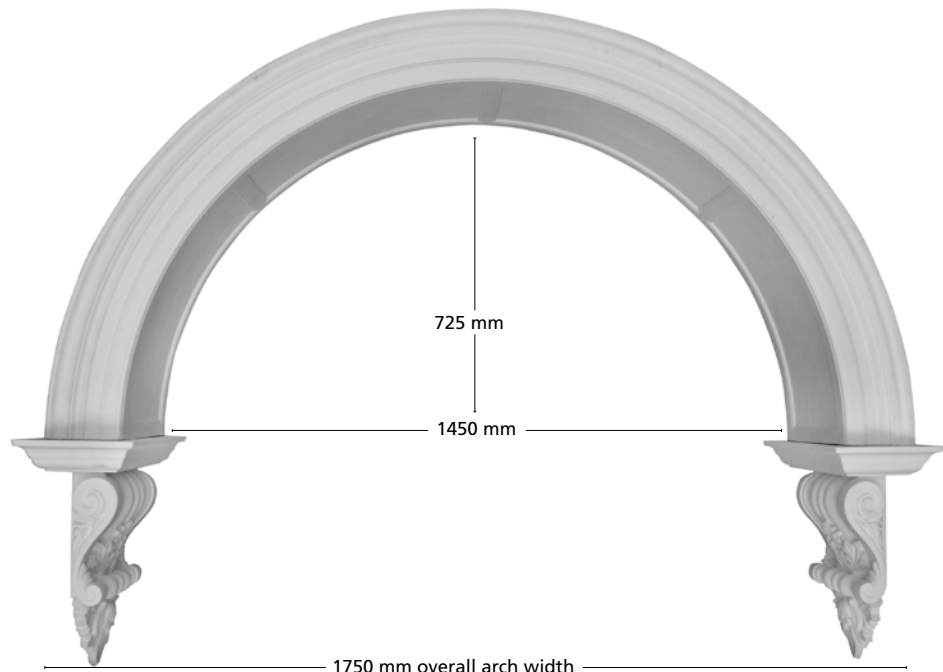

Can be custom made to suit any wall thickness POA.

Semi Elliptical Arch



ASE5 (Vic) 260 mm WALL THICKNESS

Arch Set Includes:

- 1 x Arch Section
- 2 x Plinths AAP3
- 2 x Corbels

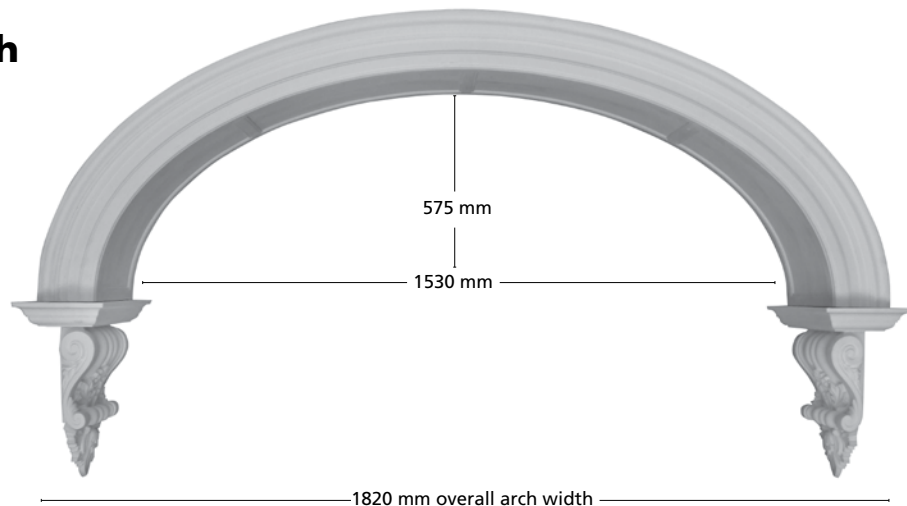

Can be custom made to suit any wall thickness POA.

Semi Elliptical Arch

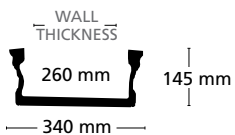

ASE6 (Vic) 260 mm WALL THICKNESS

Arch Set Includes:

- 1 x Arch Section
- 2 x Plinths AAP3
- 2 x Corbels

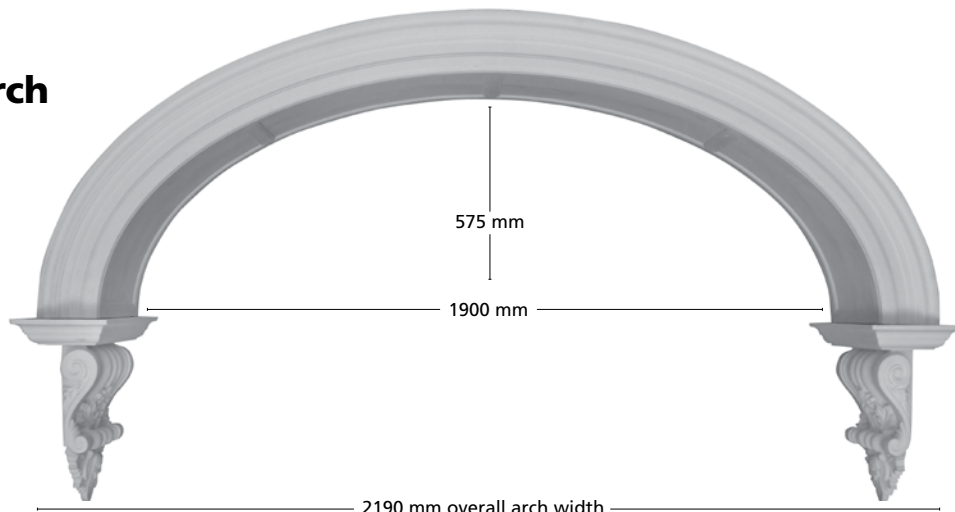

Can be custom made to suit any wall thickness POA.

ALL DIMENSIONS ARE APPROXIMATE

Semi Elliptical Arch

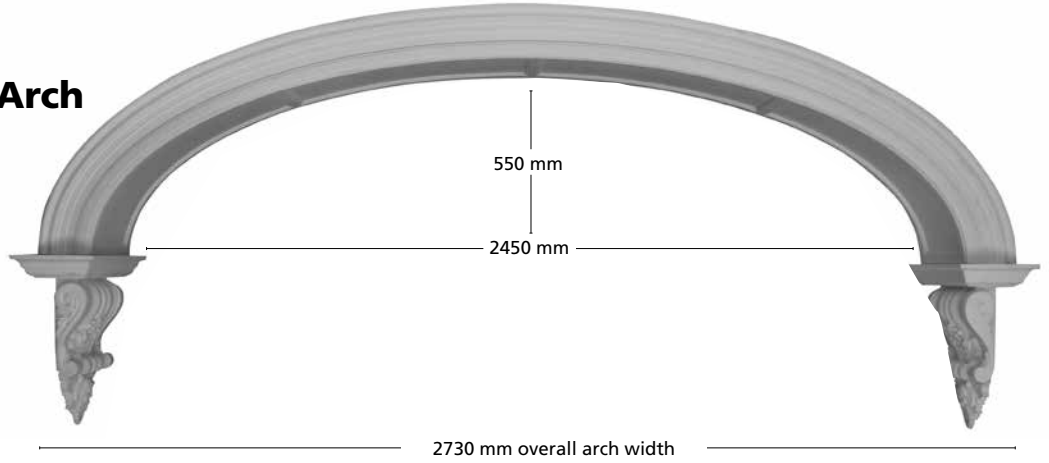
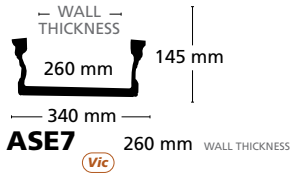

Can be custom made to suit any wall thickness POA.

Arch Set Includes:

- 1 x Arch Section
- 2 x Plinths AAP3
- 2 x Corbels
- Optional Extras
- 1 x A9 Keystone Set (optional POA)

Adjustable Elliptical Arch

- AE1** Col 135 mm WALL THICKNESS
- AE2** Col 150 mm WALL THICKNESS
- AE3** Col 205 mm WALL THICKNESS
- AE4** Col 260 mm WALL THICKNESS
- AEE1-4** (Extesion pieces)

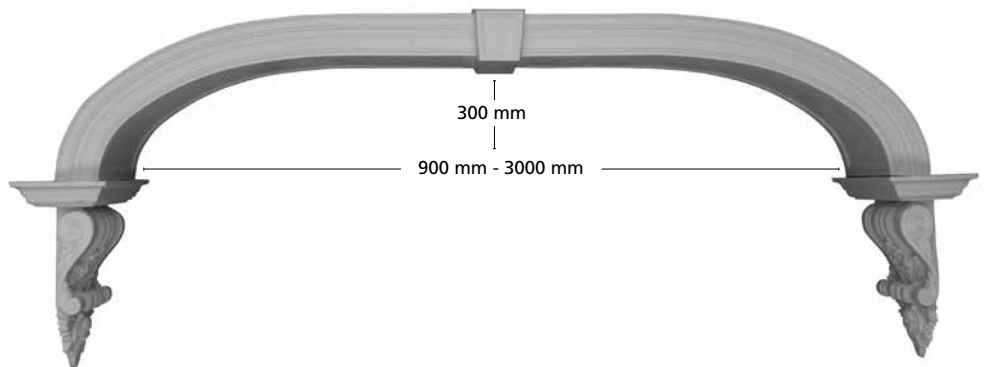

Extensions available in 2000 mm sections. Can be custom made to suit any wall thickness. POA

Arch Set Includes:

- 2 x Arch Section
- 2 x Plinths
- 2 x Corbels
- Optional Extras
- 1 x A9 Keystone Set (optional POA)

Classic Arch

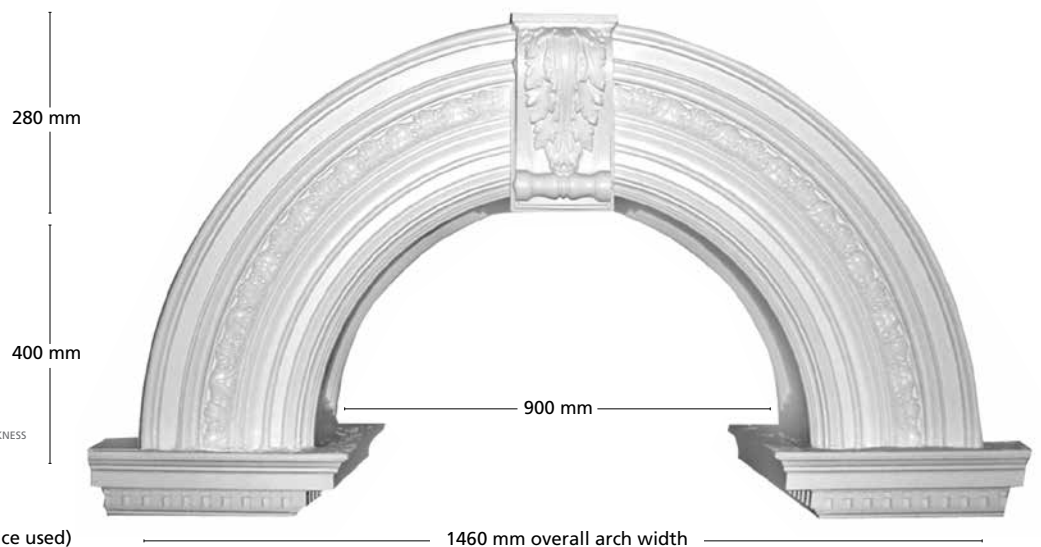
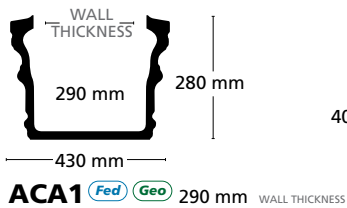

Arch available patterned or plain.

Can be custom made to suit any wall thickness. POA

Arch Set Includes:

- 2 x Arch Section
- 2 x Wrap-around Strip (A130 Cornice used)
- Optional Extras
- 1 x K5 Keystone Set (optional POA)

Classic Arch

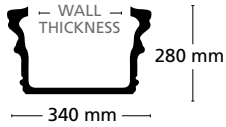

ACA2 Vic 320 mm WALL THICKNESS

Arch Set Includes:

- 1 x Arch Section
- Side pattern optional
- Suits AFP13 Pilasters
- Optional Extras
- 1 x K5 Keystone Set (optional POA)

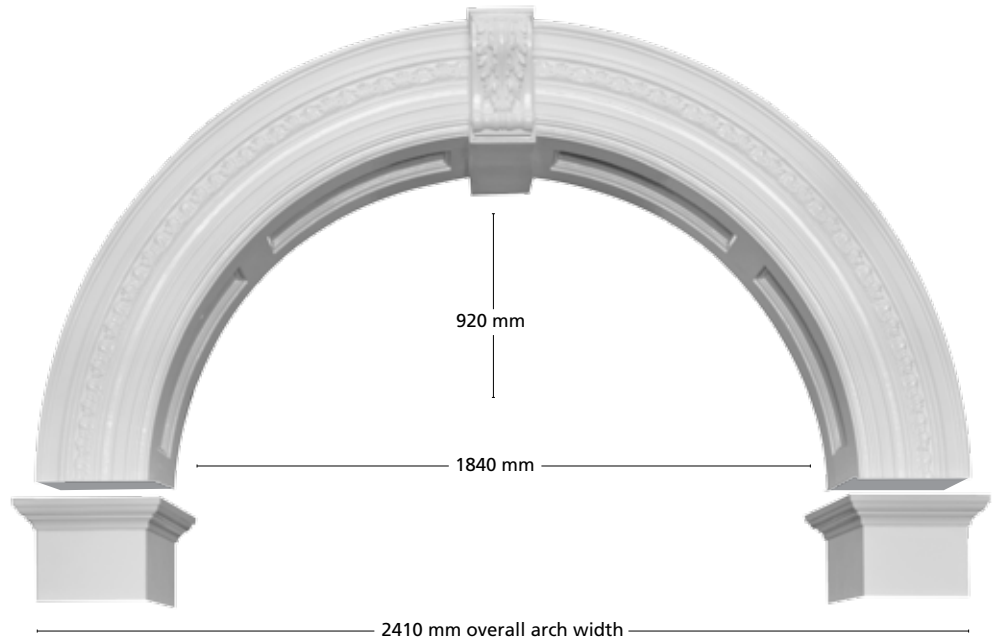

Can be custom made to suit any wall thickness. POA

Flatbacked Archway

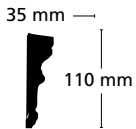

AFB1

(Per Arch Section)

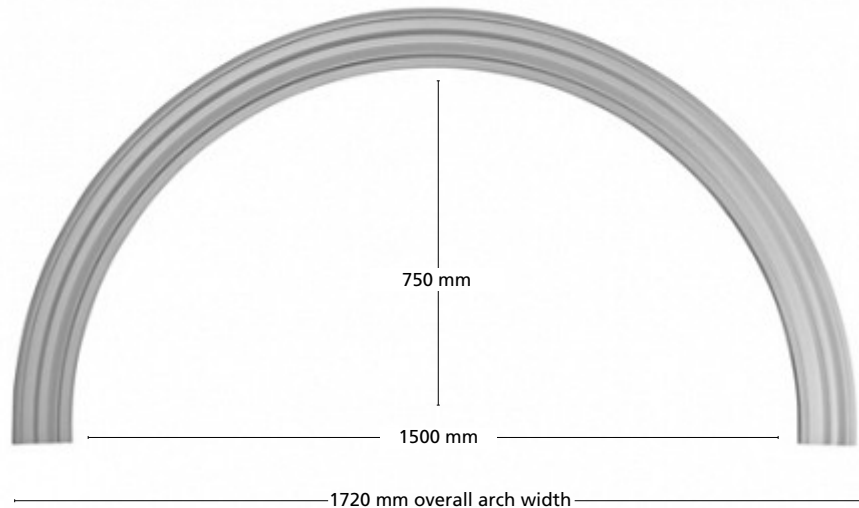

Custom Archways

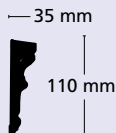

Archways can be made to any size or shaped opening. Flat- Backed or Wrap-Around. Please supply template or radius. Flat-backed archways can be made in lightweight resin for external use. Ask for more details. We can make any profile to match existing archways. POA



ALL DIMENSIONS ARE APPROXIMATE

Corbels



Pictured
AC24 Corbel
AAP3 Plinth

**AC1** Col

↓ 170 mm HEIGHT x 104 mm WIDTH
98 mm DEPTH

**AC2** Col

↓ 206 mm HEIGHT x 135 mm WIDTH
130 mm DEPTH

**AC3** Vic

↓ 215 mm HEIGHT x 121 mm WIDTH
92 mm DEPTH

**AC4** Vic

↓ 305 mm HEIGHT x 171 mm WIDTH
130 mm DEPTH

**AC5** Vic

↓ 245 mm HEIGHT x 184 mm WIDTH
80 mm DEPTH

**AC6** Vic

↓ 375 mm HEIGHT x 278 mm WIDTH
93 mm DEPTH

**AC7** Vic

↓ 407 mm HEIGHT x 271 mm WIDTH
140 mm DEPTH

**AC8** Col

↓ 225 mm HEIGHT x 101 mm WIDTH
105 mm DEPTH

**AC9** Fed

↓ 460 mm HEIGHT x 215 mm WIDTH
140 mm DEPTH

**AC10** Geo

↓ 400 mm HEIGHT x 302 mm WIDTH
124 mm DEPTH

**AC11** Vic

↓ 116 mm HEIGHT x 100 mm WIDTH
76 mm DEPTH

**AC12** Col

↓ 565 mm HEIGHT x 110 mm WIDTH
87 mm DEPTH

**AC12 (a)** Col

↓ 565 mm HEIGHT x 80 mm WIDTH
87 mm DEPTH

**AC13** Vic

↓ 160 mm HEIGHT x 160 mm WIDTH
55 mm DEPTH

**AC14** Vic

↓ 223 mm HEIGHT x 158 mm WIDTH
87 mm DEPTH

**AC15** Fed

↓ 225 mm HEIGHT x 205 mm WIDTH
80 mm DEPTH

ALL DIMENSIONS ARE APPROXIMATE

**AC16** (Vic)

330 mm HEIGHT x 180 mm WIDTH
100 mm DEPTH

**AC17** (Fed)

330 mm HEIGHT x 160 mm WIDTH
120 mm DEPTH

**AC18** (Vic)

150 mm HEIGHT x 140 mm WIDTH
95 mm DEPTH

**AC19** (Vic)

150 mm HEIGHT x 140 mm WIDTH
95 mm DEPTH

**AC20** (Vic)

135 mm HEIGHT x 125 mm WIDTH
80 mm DEPTH

**AC21** (Col)

270 mm HEIGHT x 100 mm WIDTH
95 mm DEPTH

**AC22** (Vic)

285 mm HEIGHT x 140 mm WIDTH
85 mm DEPTH

**AC23** (Fed)

300 mm HEIGHT x 185 mm WIDTH
105 mm DEPTH

**AC24** (Vic)

420 mm HEIGHT x 250 mm WIDTH
105 mm DEPTH

**AC25** (Fed)

380 mm HEIGHT x 225 mm WIDTH
100 mm DEPTH

**AC26** (Fed)

425 mm HEIGHT x 230 mm WIDTH
115 mm DEPTH

**AC27** (Vic)

245 mm HEIGHT x 230 mm WIDTH
170 mm DEPTH

**AC28** (Vic)

750 mm HEIGHT x 280 mm WIDTH
245 mm DEPTH

**AC29** (Vic)

325 mm HEIGHT x 90 mm WIDTH
60 mm DEPTH

**AC30** (Col)

190 mm HEIGHT x 75 mm WIDTH
75 mm DEPTH

**AC31** (Col)

225 mm HEIGHT x 125 mm WIDTH
75 mm DEPTH



AC32 *Col*
 ↓ 220 mm HEIGHT x 100 mm WIDTH
 100 mm DEPTH



AC33 *Fed*
 ↓ 725 mm HEIGHT x 105 mm WIDTH
 65 mm DEPTH



AC34 *Col*
 ↓ 220 mm HEIGHT x 90 mm WIDTH
 130 mm DEPTH



AC35 *Col*
 ↓ 125 mm HEIGHT x 90 mm WIDTH
 30 mm DEPTH



AC36 *Vic*
 ↓ 120 mm HEIGHT x 85 mm WIDTH
 75 mm DEPTH



AC37 *Col*
 ↓ 130 mm HEIGHT x 90 mm WIDTH
 60 mm DEPTH



AC38 *Col*
 ↓ 265 mm HEIGHT x 210 mm WIDTH
 60 mm DEPTH



AC39 *Col*
 ↓ 265 mm HEIGHT x 210 mm WIDTH
 60 mm DEPTH



AC40 *Col*
 ↓ 230 mm HEIGHT x 200 mm WIDTH
 80 mm DEPTH



AC41 *Vic*
 ↓ 460 mm HEIGHT x 280 mm WIDTH
 100 mm DEPTH



AC42 *Col*
 ↓ 270 mm HEIGHT x 315 mm WIDTH
 60 mm DEPTH



AC43 *Col*
 ↓ 140 mm HEIGHT x 115 mm WIDTH
 40 mm DEPTH



AC44 *Col*
 ↓ 230 mm HEIGHT x 50 mm WIDTH
 200 mm DEPTH



AC45 *Fed*
 ↓ 395 mm HEIGHT x 130 mm WIDTH
 120 mm DEPTH



AC46 *Fed*
 ↓ 315 mm HEIGHT x 170 mm WIDTH
 120 mm DEPTH



AC47 *Vic*
 ↓ 270 mm HEIGHT x 190 mm WIDTH
 110 mm DEPTH

ALL DIMENSIONS ARE APPROXIMATE





AC48 (Fed)
 ↓ 105 mm HEIGHT x 125 mm WIDTH
 110 mm DEPTH



AC49 (Col)
 ↓ 310 mm HEIGHT x 140 mm WIDTH
 95 mm DEPTH



AC50 (Col)
 ↓ 380 mm HEIGHT x 185 mm WIDTH
 90 mm DEPTH



AC51 (Fed)
 ↓ 270 mm HEIGHT x 220 mm WIDTH
 80 mm DEPTH



AC52 (Col)
 ↓ 140 mm HEIGHT x 305 mm WIDTH
 60 mm DEPTH



AC53 (Col)
 ↓ 215 mm HEIGHT x 110 mm WIDTH
 40 mm DEPTH



AC54 (Vic)
 ↓ 245 mm HEIGHT x 90 mm WIDTH
 85 mm DEPTH



AC55 (Col)
 ↓ 295 mm HEIGHT x 130 mm WIDTH
 85 mm DEPTH



AC56 (Col)
 ↓ 310 mm HEIGHT x 170 mm WIDTH
 95 mm DEPTH



AC57 (Fed)
 ↓ 260 mm HEIGHT x 325 mm WIDTH
 135 mm DEPTH



AC58 (Vic)
 ↓ 380 mm HEIGHT x 230 mm WIDTH
 100 mm DEPTH



AC59 (Vic)
 ↓ 230 mm HEIGHT x 150 mm WIDTH
 60 mm DEPTH



AC60 (Col)
 ↓ 205 mm HEIGHT x 85 mm WIDTH
 85 mm DEPTH



AC61 (Col)
 ↓ 510 mm HEIGHT x 205 mm WIDTH
 140 mm DEPTH



AC62 (Col)
 ↓ 300 mm HEIGHT x 260 mm WIDTH
 125 mm DEPTH



AC63 (Fed)
 ↓ 240 mm HEIGHT x 245 mm WIDTH
 95 mm DEPTH



AC64 *Fed*
↓ 365 mm HEIGHT x 140 mm WIDTH
140 mm DEPTH



AC65 *Fed*
↓ 295 mm HEIGHT x 150 mm WIDTH
100 mm DEPTH



AC66 *Col*
↓ 290 mm HEIGHT x 190 mm WIDTH
100 mm DEPTH



AC67 *Vic*
↓ 210 mm HEIGHT x 385 mm WIDTH
120 mm DEPTH

All corbels can be made using lightweight resin, for exterior use. Please ask for further details.

Wall Plaques



AMF1 *Col*
□ 315 mm x 810 mm
↓ 35 mm DEPTH
○ 605 mm x 245 mm INSIDE OVAL



AWP1 *Fed*
⊞ 260 mm x 565 mm
15 mm DEPTH



MIRROR FRAME
AMF2 *Geo*
□ 800 mm x 940 mm
440 mm x 585 mm INSIDE

ALL DIMENSIONS ARE APPROXIMATE

Arch Plinths



AAP1 Col Vic

- 200mm x 200mm AT THE TOP
- 170mm x 170mm AT THE BASE
- ↳ 45mm DEPTH



AAP2 Col Vic

- 380mm x 200mm AT THE TOP
- 350mm x 170mm AT THE BASE
- ↳ 45mm DEPTH



AAP3 Col Vic

- 385mm x 235mm AT THE TOP
- 290mm x 140mm AT THE BASE
- ↳ 60mm DEPTH



AAP4 Vic

- 300mm x 200mm AT THE TOP
- 270mm x 170mm AT THE BASE
- ↳ 45mm DEPTH



AAP5 Geo

- 370mm x 170mm AT THE TOP
- 170mm x 115mm AT THE BASE
- ↳ 75mm DEPTH



AAP6 Geo

- 370mm x 170mm AT THE TOP
- 250mm x 115mm AT THE BASE
- ↳ 75mm DEPTH



AAP7 Vic

- 645mm x 250mm AT THE TOP
- 610mm x 255mm AT THE BASE
- ↳ 30mm DEPTH



AAP8 Vic

- 210mm x 210mm AT THE TOP
- 160mm x 160mm AT THE BASE
- ↳ 115mm DEPTH
TO SUIT WALL THICKNESS 120mm. DEPTH 130mm



AAP9 Col

- 420mm x 290mm AT THE TOP
- 300mm x 180mm AT THE BASE
- ↳ 275mm DEPTH
TO SUIT WALL THICKNESS 270mm. DEPTH 160mm



AAP10 Col

- 280mm x 180mm AT THE TOP
- 215mm x 120mm AT THE BASE
- ↳ 55mm DEPTH
TO SUIT WALL THICKNESS 200mm X 110mm



AAP11 Col

- 390mm x 256 mm AT THE TOP
- 170mm x 120mm AT THE BASE
- ↳ 55mm DEPTH
TO SUIT WALL THICKNESS 270mm X 160mm DEPTH



AAP12 Vic

- 170mm x 215mm AT THE TOP
- 170mm x 215mm AT THE BASE
- ↳ 60mm DEPTH
TO SUIT WALL THICKNESS 200mm X 110mm DEPTH
Can be cut and mitred to wrap wall using extra sections.



Arch Keystones



K1 Geo
□ 170mm x 215mm
↳ 60mm DEPTH
Suits Arch Profile 140 mm



K2 Col Vic
□ 105mm x 245mm
↳ 20mm DEPTH
Suits AR69 Ceiling Strip Set



K3 Art
□ 210mm x 225mm
↳ 100mm DEPTH
Suits Arch Profile 140 mm



K4 Col Vic
□ 180mm x 260mm
↳ 100mm DEPTH
Suits Arch Profile 230 mm



K5 Col Vic
□ 170mm x 307mm
↳ 60mm DEPTH
Suits ACA1 & ACA2 Classic Archway



K7 Col Vic
□ 120mm x 100 mm
↳ 25mm DEPTH
Suits CA2 Corner Archway

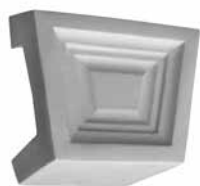

K8 Col Vic
□ 105mm x 85mm
↳ 35mm DEPTH
Suits RA1 and RA2 Robe Arch



K9 Col Vic
□ 120 mm x 125mm
↳ 60mm DEPTH
Suits AE1 - AE4, ASE1 and AB1 Archways



K10 Col Vic
□ 150 mm x 170mm
↳ 60mm DEPTH
Suits Arch Profile 145 mm



K11 Vic
□ 170 mm x 220mm
↳ 55mm DEPTH

ALL DIMENSIONS ARE APPROXIMATE

External Staffs



AES1 Col Vic
50 mm x 50 mm
↓
3000 mm HEIGHT

Can be cut & rejoined to length onsite



AES2 Col Vic
50 mm x 50 mm
↓
3000 mm HEIGHT

Can be cut & rejoined to length onsite



AES3 Col Vic
60 mm x 60 mm FROM CORNER
↓
2100 mm HEIGHT

Can be cut & rejoined to length onsite

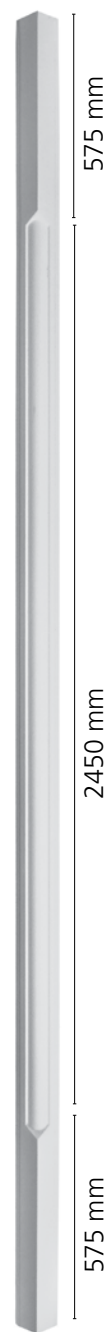

AES4 Col Vic
70 mm x 70 mm FROM CORNER
↓
up to 3600 mm HEIGHT

Can be cut & rejoined to length onsite



External staffs are used on external corners of walls set flush into walls eg. Archway openings and chimney breasts. A cut can be made towards bottom to fit to desired height by removing a section then rejoining. Please ask for more information. Please note that plasterboard should be stopped 70mm short each side when installing External Staffs

Pictured
AES2 External Staff, AC24 Corbel & AAP3 Plinth

Firesurrounds



Pictured
AFS4 Firesurround



AFS1 Geo

□ 1487 mm x 1132 mm

↓ 190 mm MANTLE DEPTH 145 mm FOOT DEPTH

**AFS2** Vic

□ 1616 mm x 1110 mm

↓ 230 mm MANTLE DEPTH 210 mm FOOT DEPTH

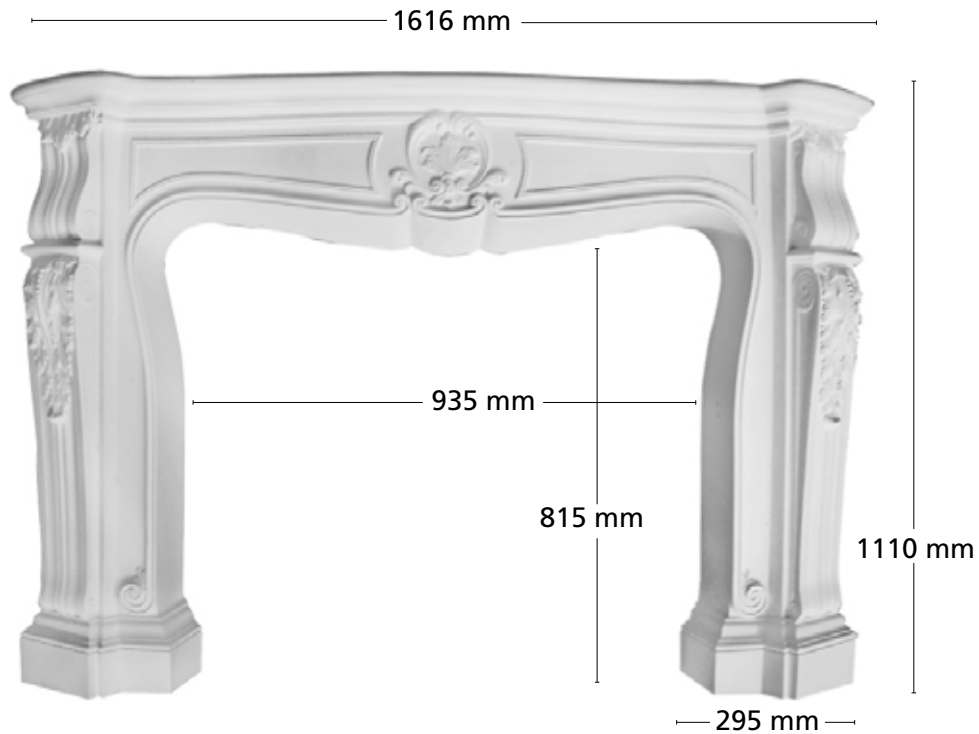
**Fire Resistance**

Plaster-glass is made from non-combustible gypsum and fibreglass. It will not burn, speed flame, evolve heat or smoke. Can also be painted in marble, granite or textured finish onsite by expert painters. Please ask for more information.

Visit us instore or order online at www.allplasta.com.au

AOM4 Fed

□ 1220 mm x 1215 mm

↓ 80 mm DEPTH Available with mirror. POA



AFS4 Fed

□ 1500 mm x 1145 mm

↓ 200 mm MANTLE DEPTH

155 mm FOOT DEPTH

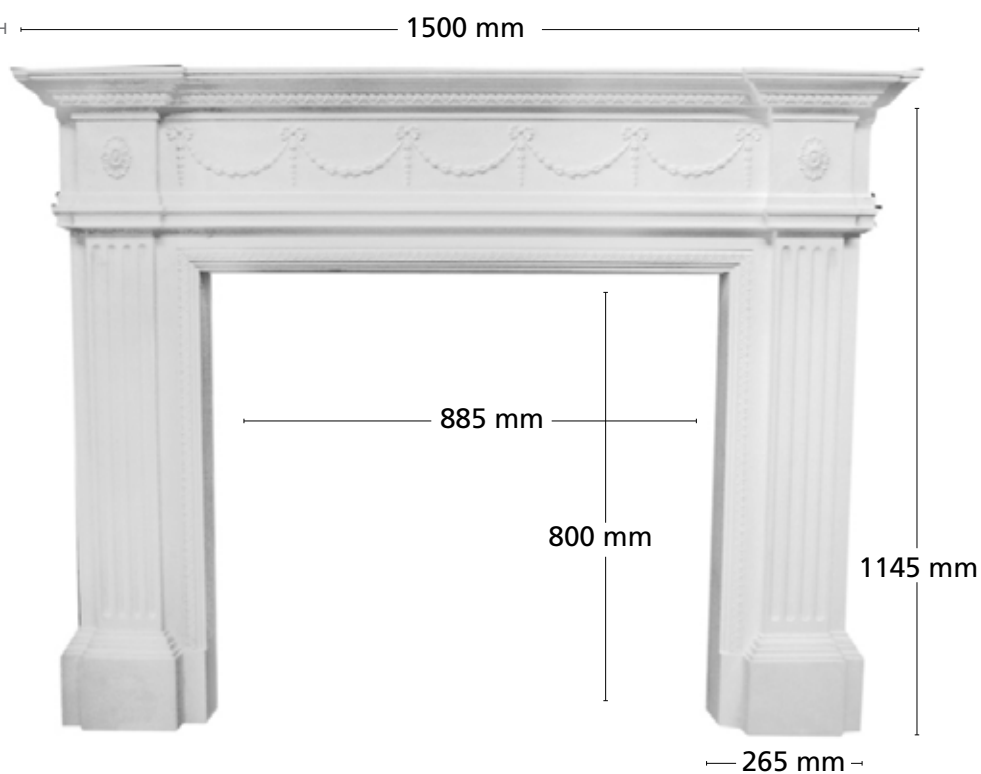

ALL DIMENSIONS ARE APPROXIMATE

AFS3 Geo

□ 1736 mm x 1163 mm

↓ 210 mm MANTLE DEPTH 165 mm FOOT DEPTH

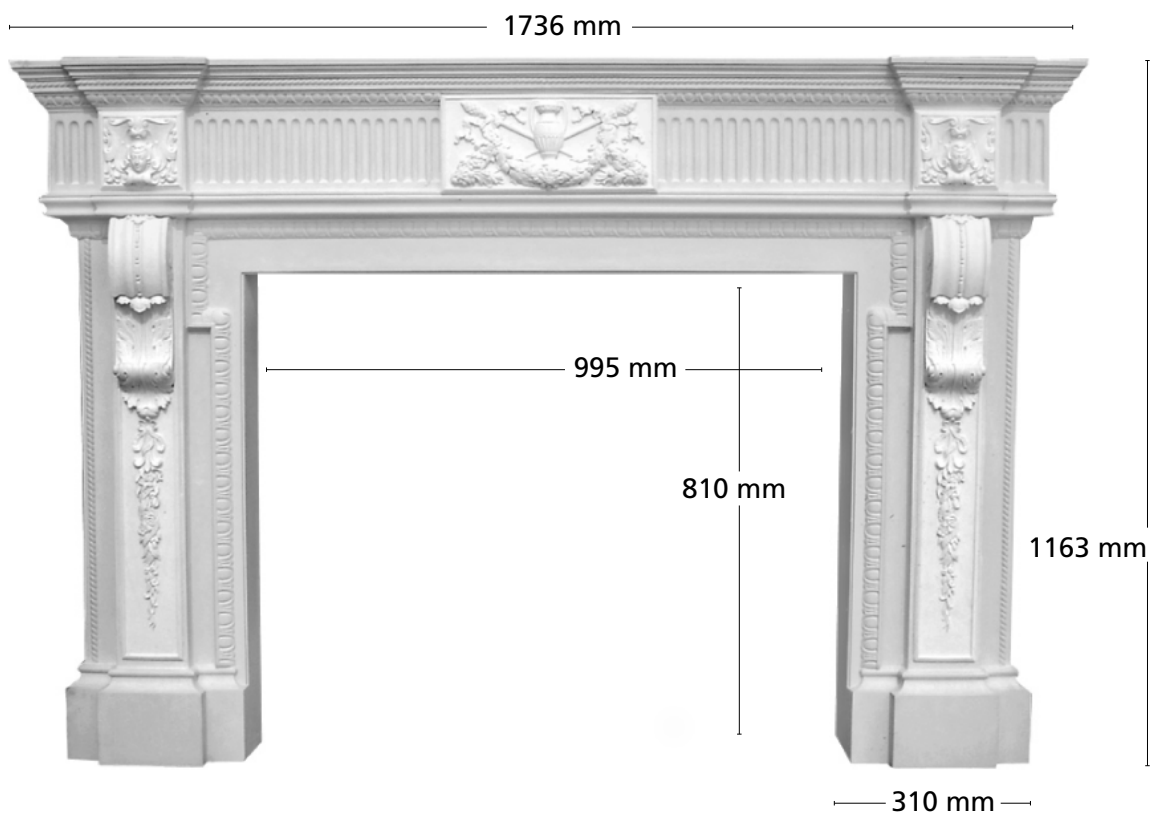
**AFS5** Mod Col

□ 1400 mm x 1140 mm

↓ 170 mm MANTLE DEPTH 130 mm FOOT DEPTH



AFS6 Geo

□ 1500 mm x 1145 mm
↓ 195 mm MANTLE DEPTH 155 mm FOOT DEPTH

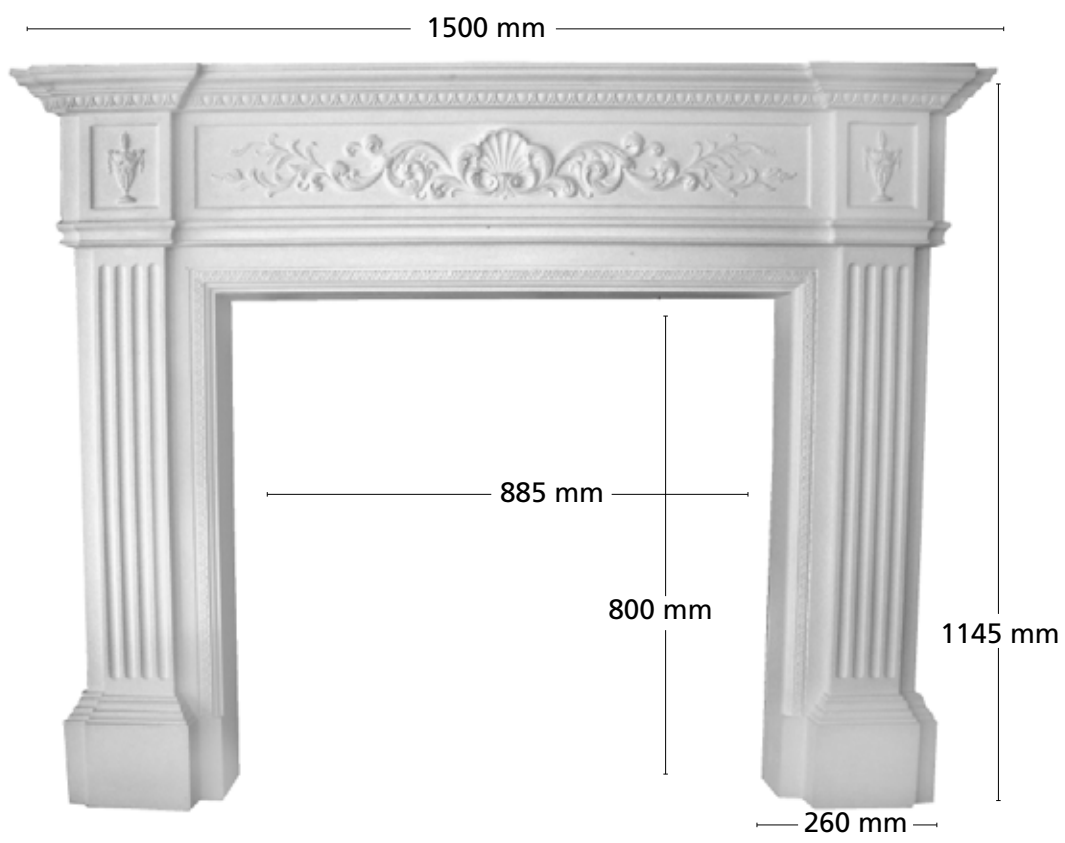

AFS7 Mod Col

□ 1560 mm x 1190 mm
↓ 170 mm MANTLE DEPTH 130 mm FOOT DEPTH

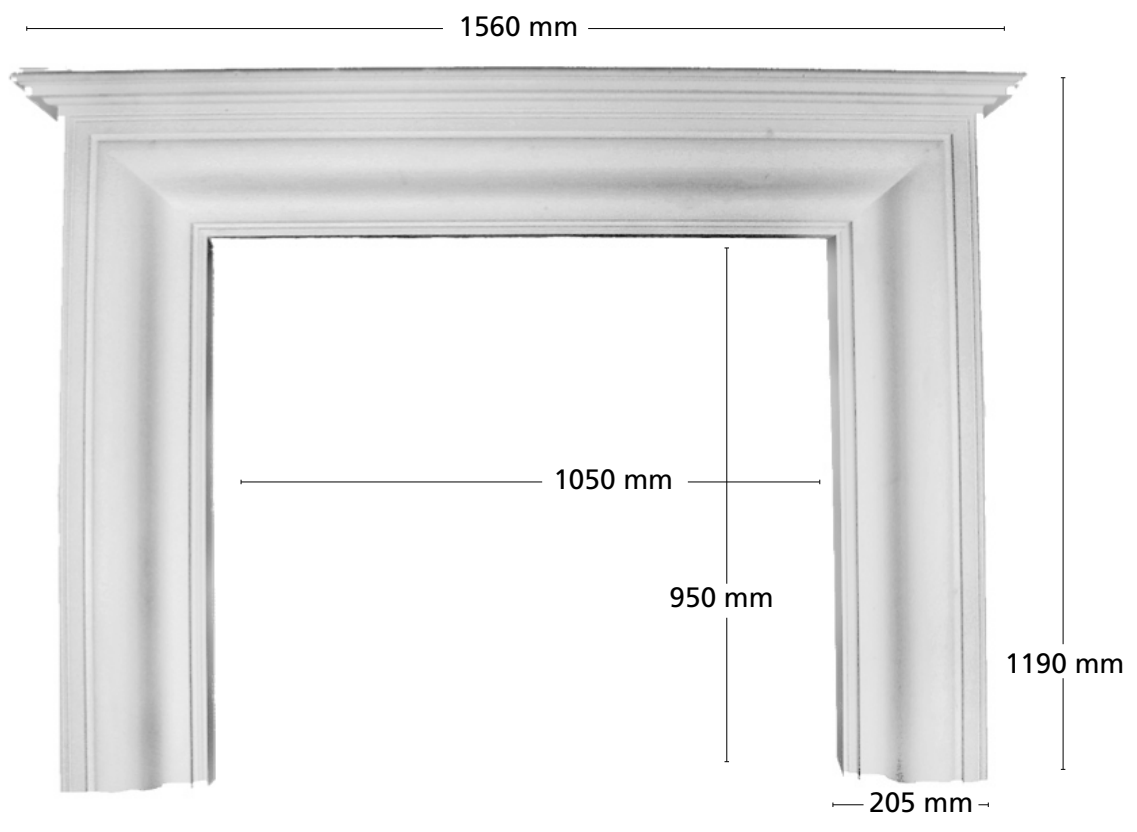

ALL DIMENSIONS ARE APPROXIMATE

AFS8 Geo

□ 1736 mm x 1163 mm

↓ 210 mm MANTLE DEPTH 165 mm FOOT DEPTH

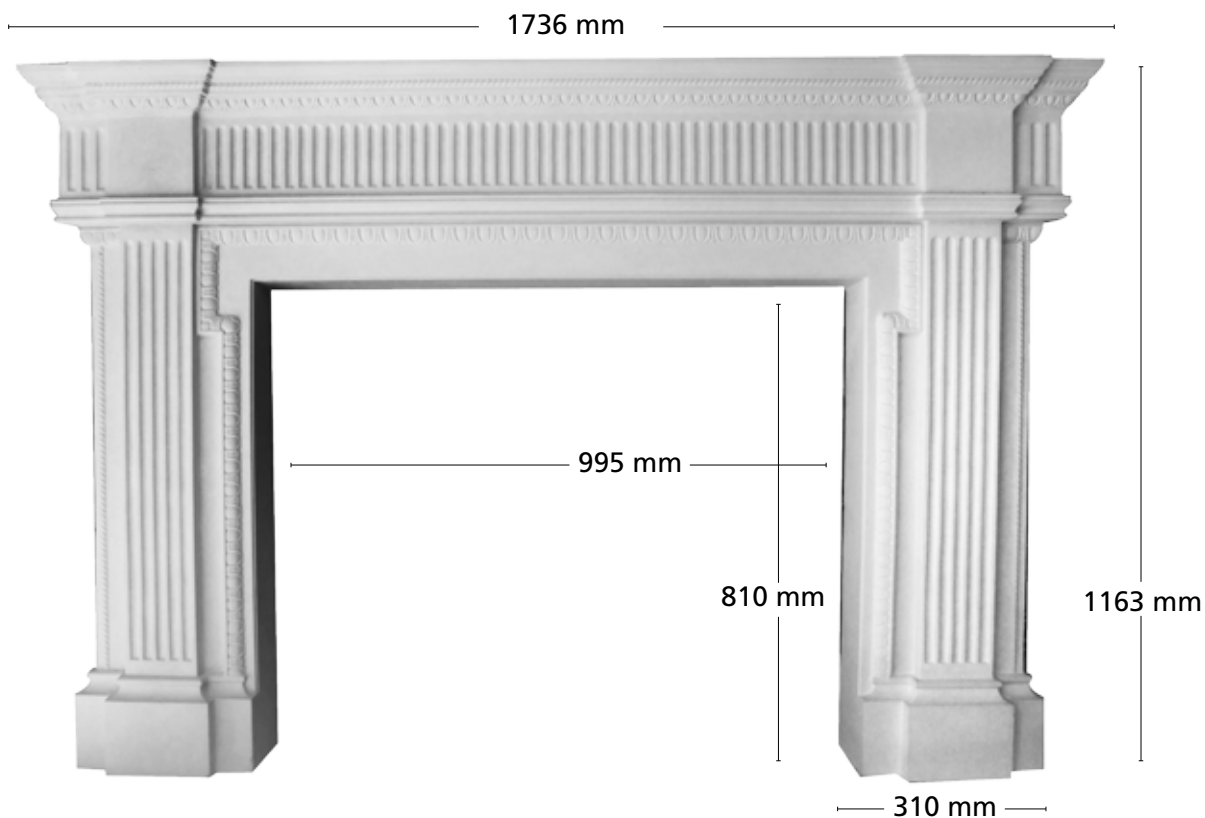
**AFS9A** Col

1135 mm

AFS9B Col

Using AC23 corbel



1135 mm

↓ 230 mm WIDTH AT TOP 170 mm DEPTH AT TOP

↓ 220 mm WIDTH AT BASE 80 mm DEPTH AT BASE





Pictured
SR A149 used in coffered ceilings



Pilasters



Pictured
AFP13 Pilaster and ACA2 Classic Archway



AFP1 Geo
WRAP AROUND PILASTER

Cap Width - 260mm
Cap Depth - 155mm
Shaft Width - 205mm
Shaft Depth - 100mm
Base Width - 260mm
Base Depth - 155mm
Height - 2200mm
TO SUIT WALL THICKNESS
120MM



AFP2 Geo
WRAP AROUND PILASTER

Cap Width - 290mm
Cap Depth - 150mm
Shaft Width - 230mm
Shaft Depth - 105mm
Base Width - 150mm
Base Depth - 290mm
Height - 1800mm
TO SUIT WALL THICKNESS
200MM



AFP3 Geo
FLATBACKED PILASTER

Cap Width - 210mm
Cap Depth - 80mm
Shaft Width - 160mm
Shaft Depth - 45mm
Base Width - 210mm
Base Depth - 70mm
Height - 2400mm



AFP4 Geo
FLATBACKED PILASTER

Width - 180mm
Depth - 20mm
Height - 2120mm
TO BE SET INTO WALL



AFP5 Geo
FLATBACKED PILASTER

Cap Width - 115mm
Cap Depth - 30mm
Shaft Length - mm
Shaft Depth - 30mm
Base Width - 115mm
Base Depth - 35mm
Height - 2275mm

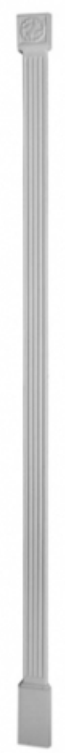

AFP6 Geo
FLATBACKED PILASTER

Cap Width - 95mm
Cap Depth - 30mm
Shaft Width - 70mm
Shaft Depth - 15mm
Base Width - 95mm
Base Depth - 25mm
Height - 2120mm



AFP7 Geo
FLATBACKED PILASTER

Cap Width - 100mm
Shaft Width - 100mm
Shaft Depth - 25mm
Base Width - 100mm
Base Depth - 25mm
Height - 2260mm



AFP8 Geo
FLATBACKED PILASTER

Width - 160mm
Depth - 25mm
Height - 3000mm



AFP9 Geo
FLATBACKED PILASTER

Width - 160mm
Depth - 25mm
Height - 2230mm

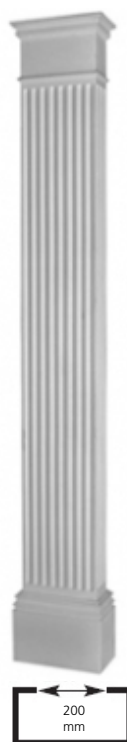

AFP10 Geo
FLATBACKED PILASTER

Cap Width - 310mm
CapDepth - 150mm
Shaft Width - 260mm
Shaft Depth - 100mm
Base Width - 310mm
Base Depth - 150mm
Height - 2095 mm
TO SUIT WALL THICKNESS
200MM

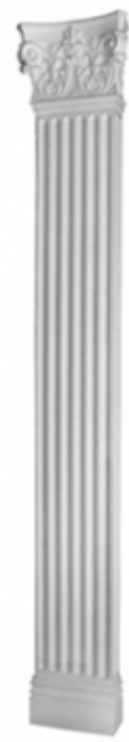

AFP11 Geo
FLATBACKED PILASTER

Cap Width - 390mm
Cap Depth - 150mm
Shaft Width - 275mm
Shaft Depth - 95mm
Base Width - 305mm
Base Depth - 110mm
Height - 2400mm



AFP12 Geo
WRAP AROUND PILASTER

Cap Width - 280mm
Cap Depth - 280mm
Shaft Width - 230mm
Shaft Depth - 230mm
Base Width - 280mm
Base Depth - 280mm
Height - 1900mm
TO SUIT WALL THICKNESS -
200MM

ALL DIMENSIONS ARE APPROXIMATE

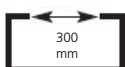

AFP13 Geo
WRAP AROUND PILASTER

Cap Width - 435mm
Cap Depth - 375mm
Shaft Width - 340mm
Shaft Depth - 280mm
Base Width - 340mm
Base Depth - 280mm
Height - 1825mm
TO SUIT WALL THICKNESS - 300MM



AFP13A Geo
WRAP AROUND PILASTER

Cap Width - 380mm
Cap Depth - 380mm
Shaft Width - 280mm
Shaft Depth - 280mm
Base Width - 280mm
Base Depth - 280mm
Height - 2500mm
TO SUIT WALL THICKNESS - 255MM



AFP14 Geo
WRAP AROUND PILASTER

Cap Width - 435mm
Cap Depth - 230mm
Shaft Width - 340mm
Shaft Depth - 140mm
Base Width - 340mm
Base Depth - 140mm
Height - 2070mm
TO SUIT WALL THICKNESS - 300MM



AFP15 Geo
FLATBACKED PILASTER

Shaft Width - 220mm
Shaft Depth - 50mm
Base Width - 250mm
Base Depth - 70mm
Height - 2050mm

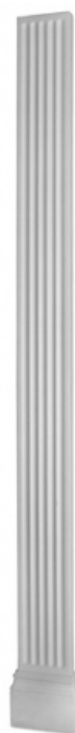

AFP16 Geo
FLATBACKED PILASTER

Shaft Width - 200mm
Shaft Depth - 50mm
Base Width - 250mm
Base Depth - 65mm
Height - 2530mm



AFP17 (a) Geo
FLATBACKED PILASTER

2 FLUTE
Cap Width - 165mm
Cap Depth - 60mm
Shaft Width - 105mm
Shaft Depth - 30mm
Base Width - 135mm
Base Depth - 40mm
Height - 3600mm



AFP17 (b) Geo
FLATBACKED PILASTER

3 FLUTE
Cap Width - 310mm
Cap Depth - 60mm
Shaft Width - 150mm
Shaft Depth - 30mm
Base Width - 180mm
Base Depth - 40mm
Height - 3600mm



AFP17 (c) Geo
FLATBACKED PILASTER

4 FLUTE
Cap Width - 255mm
Cap Depth - 60mm
Shaft Width - 195mm
Shaft Depth - 30mm
Base Width - 225mm
Base Depth - 40mm
Height - 3600mm



AFP17 (d) Geo
FLATBACKED PILASTER

5 FLUTE
Cap Width - 300mm
Cap Depth - 60mm
Shaft Width - 235mm
Shaft Depth - 30mm
Base Width - 270mm
Base Depth - 40mm
Height - 3600mm

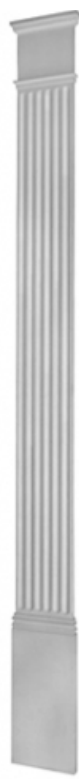

AFP17 (e) Geo
FLATBACKED PILASTER

6 FLUTE
Cap Width - 345mm
Cap Depth - 60mm
Shaft Width - 285mm
Shaft Depth - 30mm
Base Width - 315mm
Base Depth - 40mm
Height - 3600mm

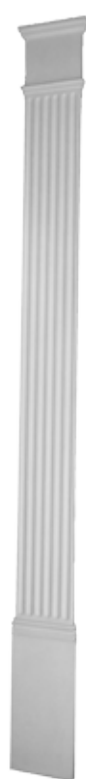

AFP17 (f) Geo
FLATBACKED PILASTER

7 FLUTE
Cap Width - 390mm
Cap Depth - 60mm
Shaft Width - 325mm
Shaft Depth - 30mm
Base Width - 360mm
Base Depth - 40mm
Height - 3600mm



AFP17 (g) Geo
FLATBACKED PILASTER

8 FLUTE
Cap Width - 430mm
Cap Depth - 60mm
Shaft Width - 370mm
Shaft Depth - 30mm
Base Width - 400mm
Base Depth - 40mm
Height - 3600mm



AFP17 (h) Geo
FLATBACK PILASTER

9 FLUTE
Cap Width - 480mm
Cap Depth - 60mm
Shaft Width - 415mm
Shaft Depth - 30mm
Base Width - 450mm
Base Depth - 40mm
Height - 3600mm

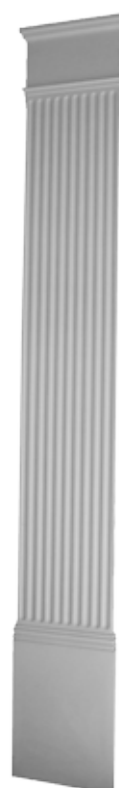

AFP17 (i) Geo
FLATBACK PILASTER

10 FLUTE
Cap Width - 520mm
Cap Depth - 60mm
Shaft Width - 455mm
Shaft Depth - 30mm
Base Width - 490mm
Base Depth - 40mm
Height - 3600mm

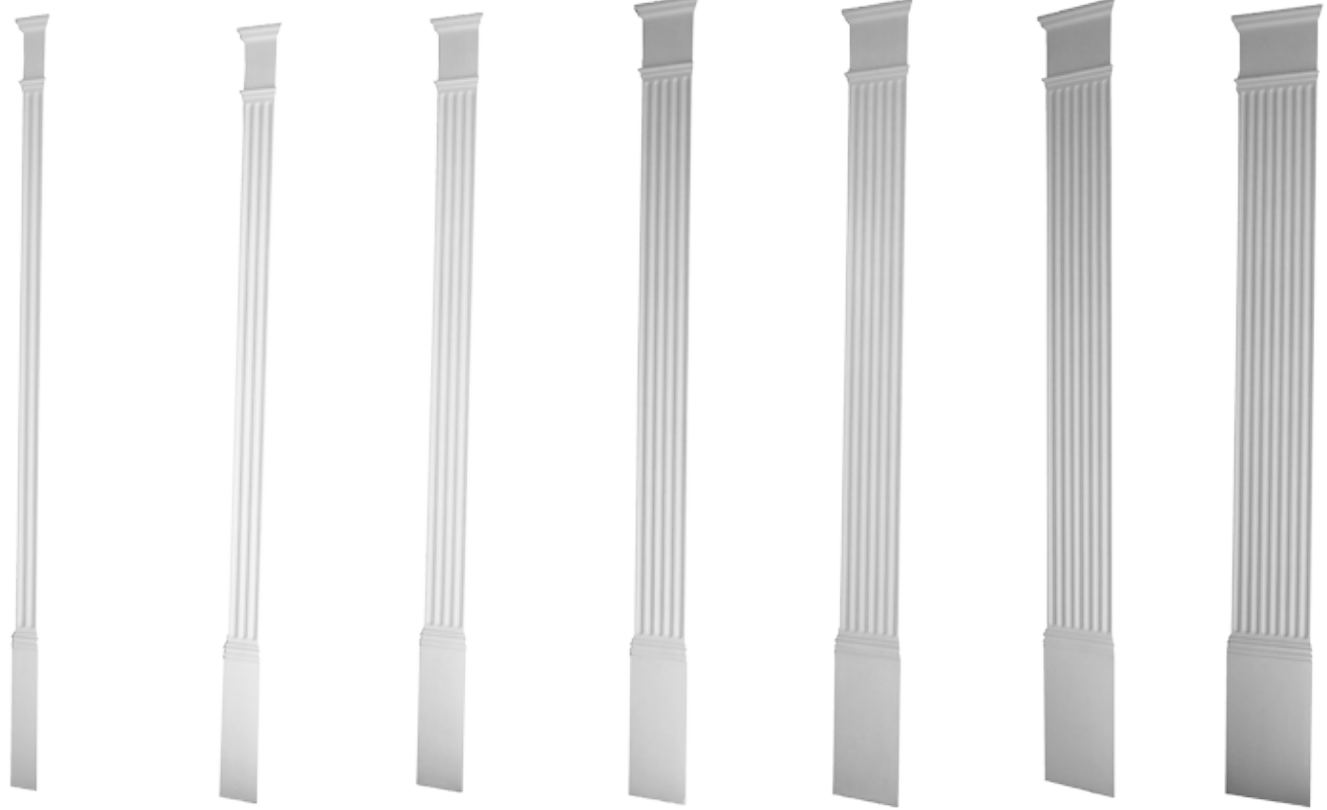

AFP18 (a)  MITRED PILASTER
 2 FLUTE
 Cap Width - 165mm
 Cap Depth - 60mm
 Shaft Width - 105mm
 Shaft Depth - 30mm
 Base Width - 135mm
 Base Depth - 40mm
 Height - 3600mm
TO ENCASE WALL

AFP18 (b)  MITRED PILASTER
 3 FLUTE
 Cap Width - 310mm
 Cap Depth - 60mm
 Shaft Width - 150mm
 Shaft Depth - 30mm
 Base Width - 180mm
 Base Depth - 40mm
 Height - 3600mm
TO ENCASE WALL

AFP18 (c)  MITRED PILASTER
 4 FLUTE
 Cap Width - 255mm
 Cap Depth - 60mm
 Shaft Width - 195mm
 Shaft Depth - 30mm
 Base Width - 225mm
 Base Depth - 40mm
 Height - 3600mm
TO ENCASE WALL

AFP18 (d)  MITRED PILASTER
 5 FLUTE
 Cap Width - 300mm
 Cap Depth - 60mm
 Shaft Width - 235mm
 Shaft Depth - 30mm
 Base Width - 270mm
 Base Depth - 40mm
 Height - 3600mm
TO ENCASE WALL

AFP18 (e)  MITRED PILASTER
 6 FLUTE
 Cap Width - 345mm
 Cap Depth - 60mm
 Shaft Width - 285mm
 Shaft Depth - 30mm
 Base Width - 315mm
 Base Depth - 40mm
 Height - 3600mm
TO ENCASE WALL

AFP18 (f)  MITRED PILASTER
 7 FLUTE
 Cap Width - 390mm
 Cap Depth - 60mm
 Shaft Width - 325mm
 Shaft Depth - 30mm
 Base Width - 360mm
 Base Depth - 40mm
 Height - 3600mm
TO ENCASE WALL

AFP18 (g)  MITRED PILASTER
 8 FLUTE
 Cap Width - 430mm
 Cap Depth - 60mm
 Shaft Width - 370mm
 Shaft Depth - 30mm
 Base Width - 400mm
 Base Depth - 40mm
 Height - 3600mm
TO ENCASE WALL

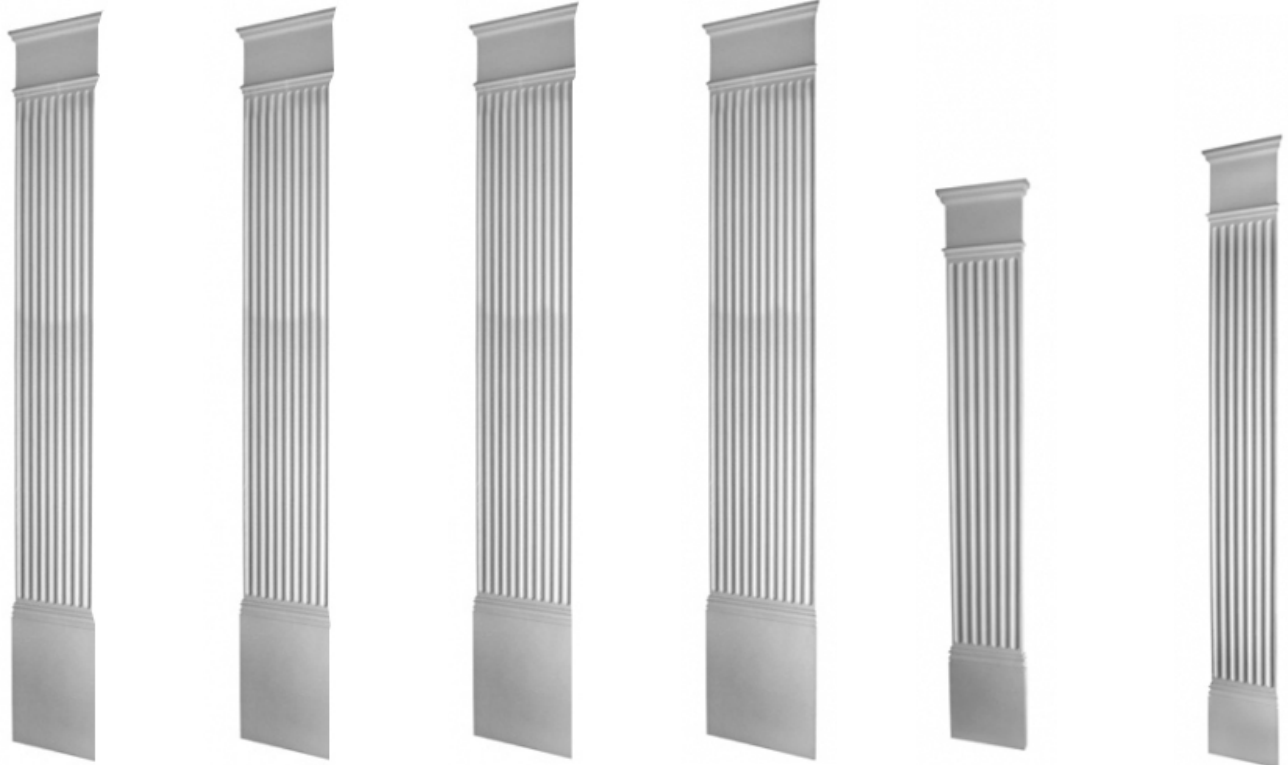

AFP18 (h)  MITRED PILASTER
 9 FLUTE
 Cap Width - 480mm
 Cap Depth - 60mm
 Shaft Width - 415mm
 Shaft Depth - 30mm
 Base Width - 450mm
 Base Depth - 40mm
 Height - 3600mm
TO ENCASE WALL

AFP18 (i)  MITRED PILASTER
 10 FLUTE
 Cap Width - 520mm
 Cap Depth - 60mm
 Shaft Width - 455mm
 Shaft Depth - 30mm
 Base Width - 490mm
 Base Depth - 40mm
 Height - 3600mm
TO ENCASE WALL

AFP18 (j)  MITRED PILASTER
 11 FLUTE
 Cap Width - 560mm
 Cap Depth - 60mm
 Shaft Width - 495mm
 Shaft Depth - 30mm
 Base Width - 530mm
 Base Depth - 40mm
 Height - 3600mm
TO ENCASE WALL

AFP18 (k)  MITRED PILASTER
 12 FLUTE
 Cap Width - 610mm
 Cap Depth - 60mm
 Shaft Width - 195mm
 Shaft Depth - 30mm
 Base Width - 225mm
 Base Depth - 40mm
 Height - 3600mm
TO ENCASE WALL

AFP19  FLATBACKED PILASTER
 Cap Width - 390mm
 Cap Depth - 600mm
 Shaft Width - 325mm
 Shaft Depth - 30mm
 Base Width - 360mm
 Base Depth - 40mm
 Height - 3600mm

AFP20  FLAT BACKED PILASTER
 Cap Width - 390mm
 Cap Depth - 280mm
 Shaft Width - 325mm
 Shaft Depth - 30mm
 Base Width - 360mm
 Base Depth - 40mm
 Height - 2520mm
TO ENCASE WALL

Pilaster Capitals



150 mm

PC1 Geo

260 mm WIDTH AT TOP X 70 mm DEPTH AT TOP
195 mm WIDTH AT BASE X 35 mm DEPTH AT BASE



285 mm

PC4 Geo

↓ 410 mm WIDTH AT TOP X 200 mm DEPTH AT TOP
⊖ 150 mm DIAM AT BASE
TO SUIT COLUMN SHAFT 150MM DIAM



325 mm

PC2 Geo

↓ 290 mm WIDTH AT TOP X 80 mm DEPTH AT TOP
190 mm WIDTH AT BASE X 40 mm DEPTH AT BASE

SUITS AFP16 PILASTER SHAFT



750 mm

PC5 Geo

↓ 1160 mm WIDTH AT TOP X 380 mm DEPTH AT TOP
655 mm WIDTH AT BASE X 185 mm DEPTH AT BASE



300 mm

PC3 Geo

↓ 460 mm WIDTH AT TOP X 100 mm DEPTH AT TOP
290 mm WIDTH AT BASE X 30 mm DEPTH AT BASE



165 mm

PC6 Geo

↓ 200 mm WIDTH AT TOP X 105 mm DEPTH AT TOP
120 mm WIDTH AT BASE X 45 mm DEPTH AT BASE

Pediments



Pictured
ADP3 Pediment and AFP1 Pilaster



APD1 (Flat Backed) Geo

□ 331 mm x 1455 mm

↓ 70 mm DEPTH

Adjustable Length

**ADP3 (Flat Backed)** Geo

Adjustable Length

150 mm

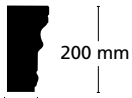

80 mm

□ 200 mm x up to 3600 mm LENGTH

Adjustable Length

**ADP4 (Flat Backed)**

Adjustable Length

□ 300 mm x Adjustable

↓ up to 3600 mm LENGTH 70 mm DEPTH

**ADP5 (Flat Backed)** Fed Vic

□ 310 mm x 1190 mm LENGTH

↓ 70 mm DEPTH

**ADP6 (Flat Backed)** Col Vic

310 mm x 800 mm

30 mm DEPTH

Can be used as an exterior decoration



ADP7 (Flat Backed) Col Vic
 390 mm x up to 2480 mm
 40 mm DEPTH



ADP8 (Flat Backed) Col Vic
 580 mm x up to 2075 mm
 1845 mm WIDTH AT BASE
 140 mm DEPTH AT TOP x 80 mm DEPTH AT BASE



ADP9 (Flat Backed) Col Vic
 500 mm x up to 1580 mm
 1355 mm WIDTH AT BASE
 140 mm DEPTH AT TOP x 80 mm DEPTH AT BASE



What is a pediment?

Pediments are usually placed above door openings and used with pilasters to create a grand opening. Some pediments can be made of fibreglass or lightweight resin for exterior use. POA

ALL DIMENSIONS ARE APPROXIMATE

Columns



Pictured
APC5 Columns with Doric Capitals
A22 Curved Cornice

Plain Columns

Manufactured in Plaster

- Columns can be custom made to suit any design requirements not shown here and to any height. (some capitals are interchangeable)
- Standard columns can be made to any height POA



APC1 (Col)
 1.0 m HIGH
 200 mm DIAMETER
 295 x 295 mm BASE

WITH DORIC CAP



APC2 (Col)
 1.1 m HIGH
 254 mm DIAMETER
 360 x 360 mm BASE

WITH DORIC CAP



APC3 (Col)
 2.7 m HIGH
 150 mm DIAMETER
 250 x 250 mm BASE

WITH DORIC CAP



APC4 (Col)
 2.7 m HIGH
 200 mm DIAMETER
 295 x 295 mm BASE

WITH DORIC CAP



APC5 (Col)
 3.210 m HIGH
 254 mm DIAMETER
 360 x 360 mm BASE

WITH IONIC CAP



APC6 (Col)
 2.9 m HIGH
 300 mm DIAMETER
 450 x 450 mm BASE

WITH DORIC CAP

Fluted Columns

Manufactured in Plaster

- Columns can be custom made to suit any design requirements not shown here and to any height.
- Base sizes as per above plain columns.
- Can also be finished in a marble, granite or textured look. Please ask for more information.
- Can be made longer. (POA)



AFC1 (Geo)
 1.0 m HIGH
 200 mm DIAMETER
 295 x 295 mm BASE

WITH IONIC CAP



AFC2 (Geo)
 1.1 m HIGH
 254 mm DIAMETER
 360 x 360 mm BASE

WITH CORINTHIAN CAP



AFC6 (Geo)
 2.8 m HIGH
 150 mm DIAMETER
 250 x 250 mm BASE

WITH IONIC CAP



AFC7 (Geo)
 2.8 m HIGH
 200 mm DIAMETER
 295 x 295 mm BASE

WITH CORINTHIAN CAP



AFC8 (Geo)
 3.265m HIGH
 254 mm DIAMETER
 360 x 360 mm BASE

WITH IONIC CAP

Capitals (Interchangeable)



Corinthian Cap

- 150 mm DIAMETER = 275 x 275 mm
- 200 mm DIAMETER = 340 x 340 mm
- 254 mm DIAMETER = 395 x 395 mm
- 300 mm DIAMETER = 455 x 455 mm



Doric Cap

- 150 mm DIAMETER = 215 x 215 mm
- 200 mm DIAMETER = 280 x 280 mm
- 254 mm DIAMETER = 335 x 335 mm
- 300 mm DIAMETER = 395 x 395 mm



Ionic Cap

- 150 mm DIAMETER = 210 x 210 mm
- 200 mm DIAMETER = 275 x 275 mm
- 254 mm DIAMETER = 330 x 330 mm
- 300 mm DIAMETER = 390 x 390 mm

ALL DIMENSIONS ARE APPROXIMATE



Wall Panels



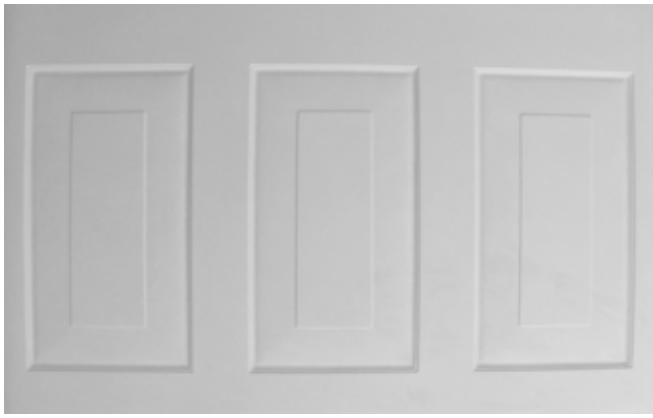

AWP1 Col Vic
 □ 800 mm x 1200 mm
 ↓ 13 mm
 AS43 Recessed chair rail strip available

AWP2 Col Vic
 □ 1200 mm x 900 mm
 ↓ 13 mm
 AS43 Recessed chair rail strip available



AWP3 Col Vic
 □ 1200 mm x 1200 mm
 ↓ 13 mm
 AS43 Recessed chair rail strip available



AP28 (Wall Panel) Geo
 □ 1210 mm x 810 mm
 ↓ 13 mm
 AS43 Recessed chair rail strip available

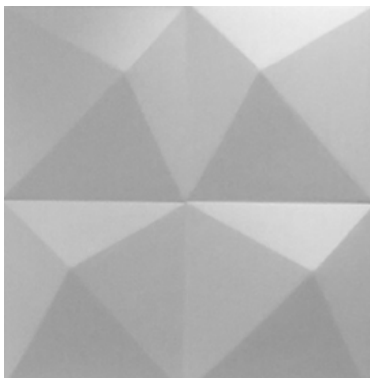

AWP9 Art
 □ 600 mm x 600 mm
 ↓ 25 mm



AWP9 made as a feature wall

**AWP5** Geo

□ 2010 mm x 900 mm

↳ 20 mm

**AWP6** Geo

□ 2010 mm x 900 mm

↳ 20 mm

**AWP7** Geo

□ 1900 mm x 900 mm

↳ 20 mm

**AWP8** Geo

□ 1025 mm x 900 mm

↳ 20mm

Wall Niches



AN1 Col
 □ 640 mm x 1070 mm
 ↓ 80 mm DEPTH 220 mm SHELF DEPTH



AN2 Col
 □ 640 mm x 1070 mm
 ↓ 80 mm DEPTH 220 mm SHELF DEPTH



AN3 Col
 □ 640 mm x 1070 mm
 ↓ 80 mm DEPTH 220 mm SHELF DEPTH



AN4 Col
 □ 1030 mm x 1630 mm
 ↓ 50 mm DEPTH 175 mm SHELF DEPTH



AN5 Col
 □ 415 mm x 870 mm
 ↓ 90 mm DEPTH 150 mm SHELF DEPTH



AN6 Col
 □ 395 x 580 mm
 ↓ 100 mm DEPTH 115 mm SHELF DEPTH



AN7 Col Vic
 □ 830 x 1620 mm
 ↓ 85 mm DEPTH
 □ 670 mm CAVITY WIDTH x 1530 mm CAVITY LENGTH
 ↓ 160 mm DEPTH

ALL DIMENSIONS ARE APPROXIMATE



Acoustic Pods

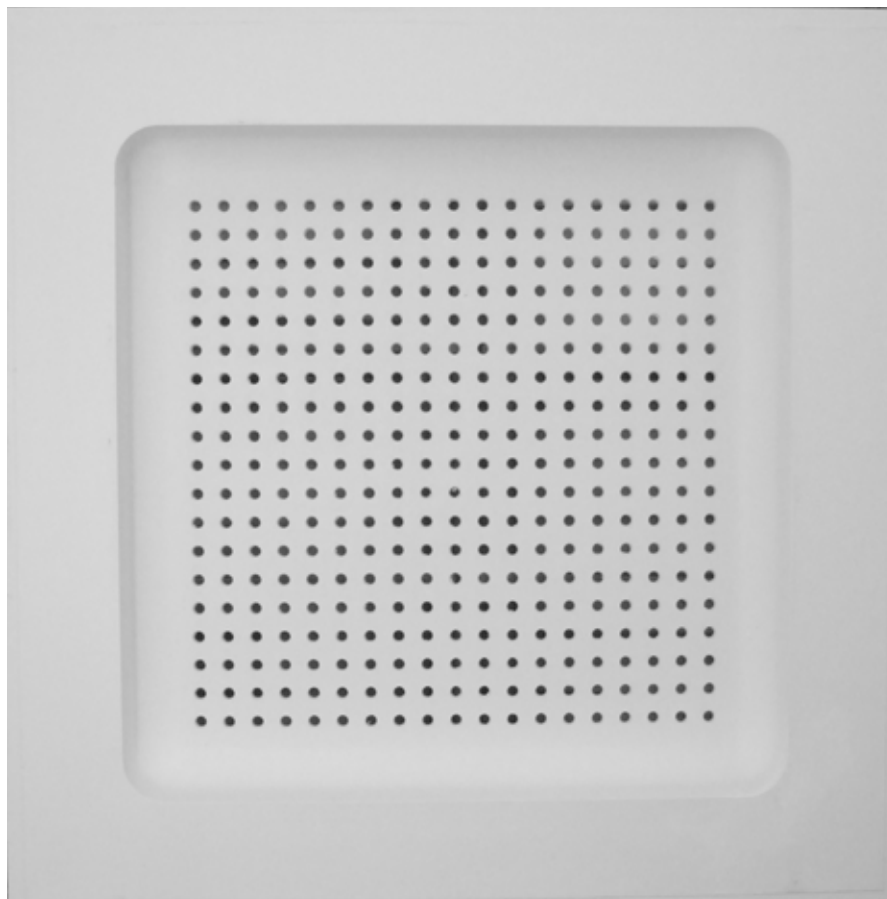

ACP1 *Mod*

□ 2125 mm x 2125 mm

↓ 200 mm DEPTH

● 361 perforated holes

φ 25 mm holes



ALL DIMENSIONS ARE APPROXIMATE

Light Sconces



ALS1 Corner Sconce Col Vic

215mm WIDTH x 215mm DEPTH
 300 mm HEIGHT

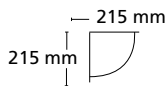

ALS2 Col Mod

420mm WIDTH x 200mm DEPTH
 120mm HEIGHT



AC62 Col

300 mm HEIGHT x 260 mm WIDTH
 125 mm DEPTH

Cornice Mitre Blocks

Cornice mitre blocks suit cornice 90mm x 90mm

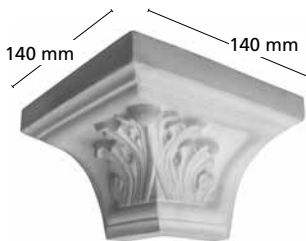

AEX1 Col Vic Geo Fed

140 mm x 140 mm
 90 mm CORNICE EXTERNAL CORNER

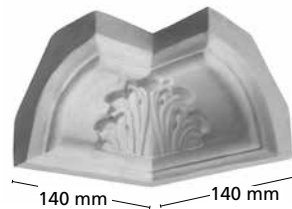

AEX2 Col Vic Geo Fed

140 mm x 140 mm
 90 mm CORNICE INTERNAL CORNER



AEX3 Col Vic Geo Fed

150mm
 90 mm CORNICE JOINER

Plaster Accessories



PA1 *Vic*
□ 90 mm x 500 mm SECTIONS
↳ 20 mm



Picture above using a combination of PA1 & PA4 to enhance A165 cornice



PA2 *Vic*
□ 90 mm x 500 mm SECTIONS
↳ 20 mm



PA3 *Vic*
□ 80 mm x 250 mm SECTIONS
↳ 20 mm



PA4 *Vic*
□ 35 mm x 500 mm SECTIONS
↳ 15 mm



PA5 *Geo* *Vic*
□ 120 mm DIAMETER
↳ 80 mm DEPTH



PA6 *Col*
□ 595 mm x 295 mm
↳ 15 mm



PA7 *Col*
□ 200 mm x 110 mm
↳ 30 mm DEPTH
SUITS CORBEL ACS



PA8 *Col*
□ 595 mm x 300 mm
↳ 20 mm



PA9 *Col*
□ 160 mm x 240 mm
↳ 40 mm DEPTH

ALL DIMENSIONS ARE APPROXIMATE

Vents



AV1 Col
□ 200 mm x 200 mm



AV2 Col
□ 255 mm x 185 mm



AV3 Fed
□ 255 mm x 180 mm



AV4 Fed
□ 310 mm x 230 mm

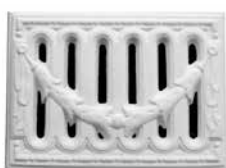

AV5 Fed
□ 285 mm x 210 mm



AV6 Fed
□ 300 mm x 190 mm



AV7 Fed
□ 300 mm x 220 mm



AV8 Vic
□ 330 mm x 195 mm



AV9 Col
□ 300 mm x 195 mm



AV10 Fed
□ 345 mm x 265 mm



AV11 Vic
□ 345 mm x 215 mm



AV12 Vic
□ 285 mm x 210 mm



AV13 Vic
□ 300 mm x 225 mm



AV14 Vic
□ 290 mm x 185 mm



AV15 Vic
□ 310 mm x 155 mm



AV16 Fed
□ 330 mm x 190 mm



AV17 Vic
□ 275 mm x 275 mm



AV18 Geo
□ 355 mm x 235 mm



AV19 Fed
□ 300 mm x 230 mm



AV20 Vic
□ 290 mm x 215 mm





AV21 *Art*
□ 295 mm x 190 mm



AV22 *Art*
□ 315 mm x 150 mm



AV23 *Art*
□ 310 mm x 195 mm



AV24 *Fed*
□ 315 mm x 235 mm

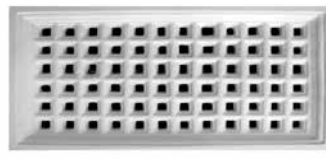

AV25 *Col*
□ 400 mm x 250 mm



AV26 *Fed*
□ 370 mm x 190 mm

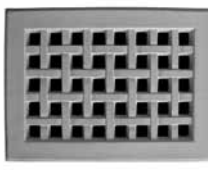

AV27 *Col*
□ 290 mm x 215 mm



AV28 *Fed*
□ 290 mm x 215 mm

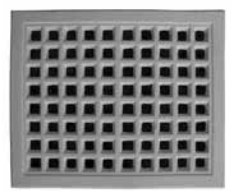

AV29 *Col*
□ 300 mm x 250 mm



AV30 *Vic*
□ 285 mm x 210 mm



AV31 *Col*
□ 285 mm x 210 mm



AV32 *Vic*
□ 340 mm x 215 mm



AV33 *Col*
□ 315 mm x 235 mm



AV34 *Fed*
□ 365 mm x 185 mm



AV35 *Vic*
□ 255 mm x 185 mm



AV36 *Vic*
□ 295 mm x 185 mm



AV37 *Col*
□ 260 mm x 155 mm



AV38 *Vic*
□ 365 mm x 215 mm



AV39 *Fed*
□ 280 mm x 200 mm



Vents can be made with wire backing.
POA

Fixing Cornices

Cutting of Mitres

Measure wall. Mitre-cut scotia to length. When a scotia or cornice has the same projection down the wall and across the ceiling, a mitre box is a handy aid.

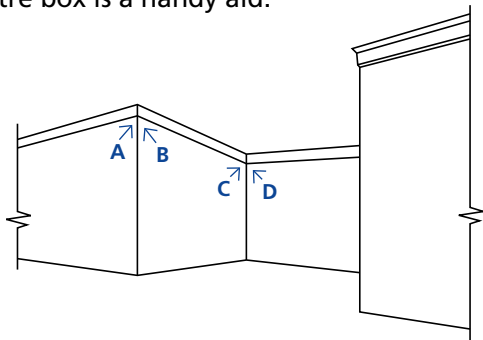

When cutting mitres, always keep the wall edge of the cornice uppermost on the outer side of the mitre box.

External Mitre

To suit position A on the ceiling illustration.

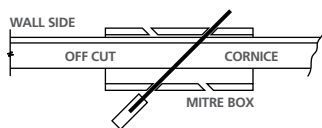

External Mitre

To suit position B on the ceiling illustration.

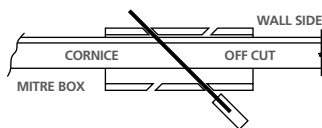

Internal Mitre

To suit position C on the ceiling illustration.

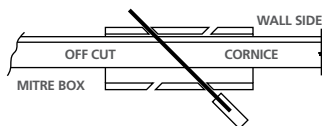

Internal Mitre

To suit position D on the ceiling illustration.

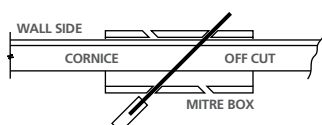

Decorative Cornices

With Decorative cornices however, the ceiling projection is generally greater than the projection down the wall. Proceed using the same principle as when using a mitre box. Position the cornice ready for cutting. Measure the ceiling projection and mark on the top member of the cornice. Draw a line from this mark to the edge of the cornice. You now have the correct angle for your cut. Use the same principle for all internal and external mitres.

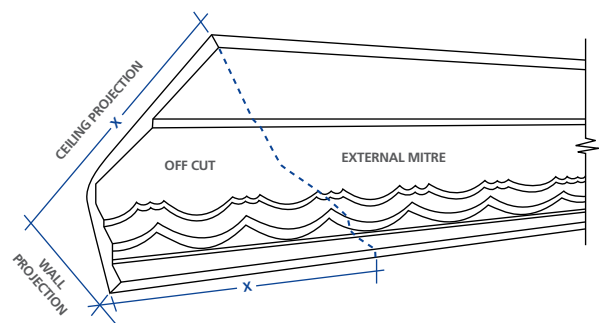

Working from the centre line of one wall, ensure that a matching module or part of a module occurs at each end of the first wall (designs are in repeating modules). Use the same principle for the other walls. It is likely that the last mitred cornice may not match, this is not considered abnormal.

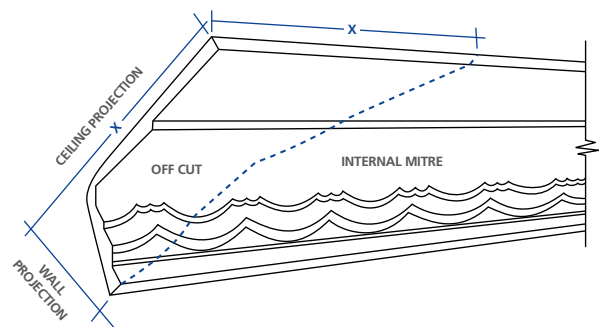

Fixing Ceiling Centres



Safety First - Organise an Electrician!

Have an electrician isolate light fittings before drilling a hole through the centre of the ceiling centre to push the light fitting wiring through.

Preparation

If ceiling is painted you can scuff with 120grit sandpaper and lightly score area where ceiling centre will cover with a stanley knife or alternatively you can paint bondcrete onto area to ensure cornice cement will adhere. If ceiling is new no preparation is necessary.

Make sure all surfaces to be glued are clean and free of flakey paint or loose material.

Installation

Mix dry cornice adhesive to the instructions on the packaging.

Apply cornice adhesive around back perimeter of ceiling centre. Be careful not to apply too much so it does not creep out from under the edge of the ceiling centre.

Push the ceiling centre into the required position on the ceiling and hold for a few minutes.

Drive two or three screws of suitable length through the ceiling centre into ceiling joist or batten and prop the ceiling centre from the floor to hold into position until adhesive sets. When propping use a soft surface to contact the ceiling centre face to eliminate surface damage. An old towel or sponge is ideal.

Wipe / scrape off excess cornice adhesive with a sponge, brush or small tool.

Once dry must be painted with sealer undercoat, then it can be painted any colour.





Pictured
A146 Cornice, AS42 Strip and AR32 Ceiling Centre



ALLPLASTA

Quality Hand Crafted Plaster Products

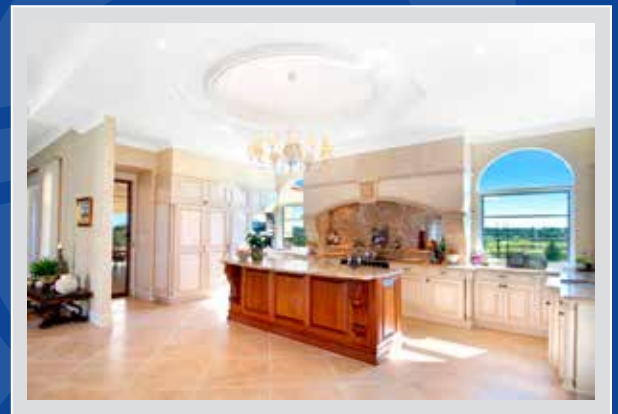
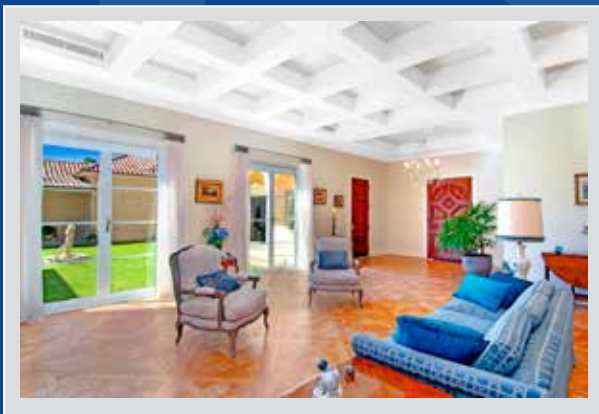

Opening Hours

Monday to Thursday - 6am - 4pm

Friday - 6am - 3pm

www.allplasta.com.au

(02) 9627 6550

sales@allplasta.com.au

PO Box 7044 Wilberforce NSW 2756

10 Box Avenue, Wilberforce NSW 2756

© Copyright Allplasta Pty Ltd 2017.

All rights reserved no part of this catalogue may be reproduced whatsoever without the written permission of the owner.